

1998 KX500 PARTS DIAGRAM

Crankcase

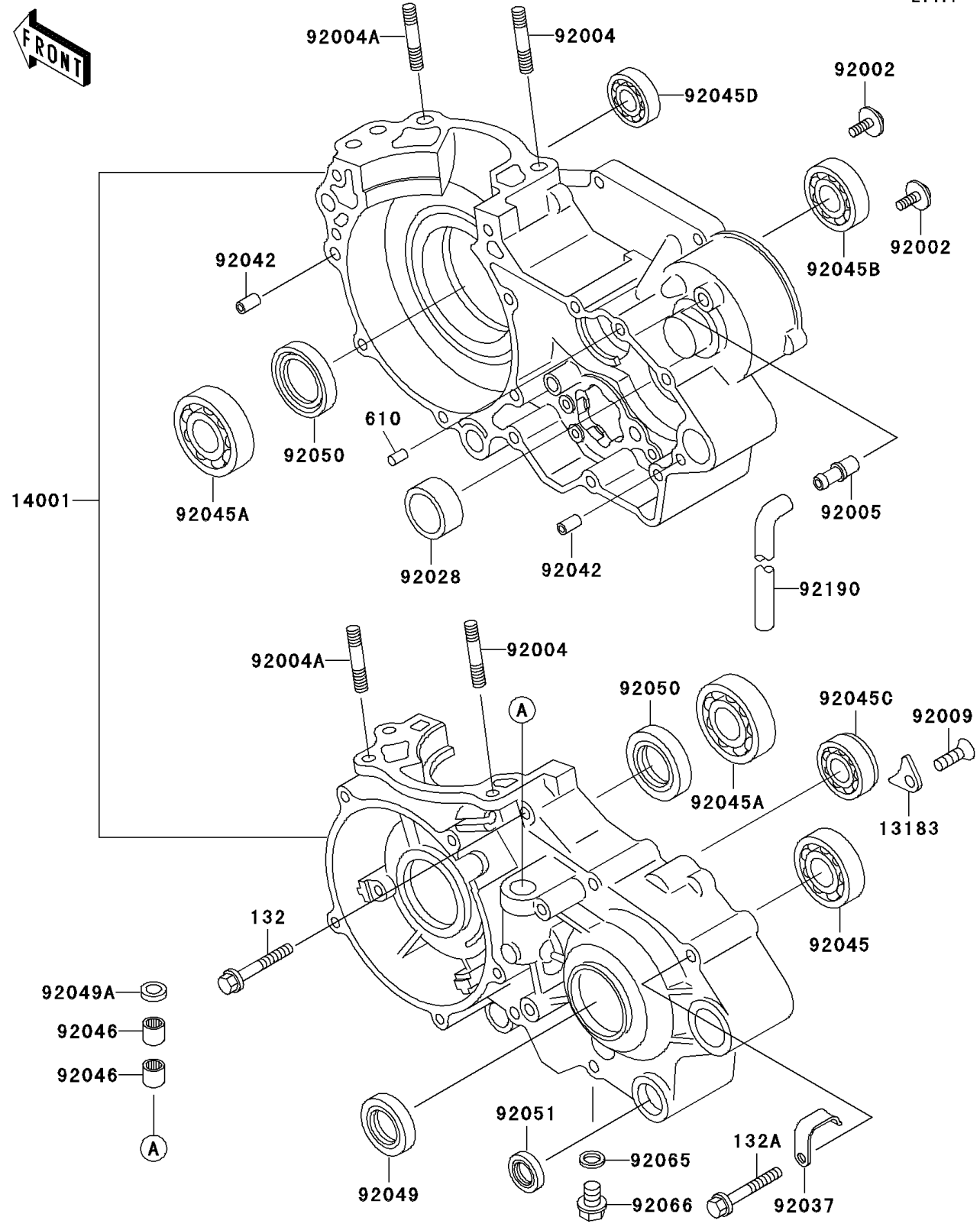

E1411



1998 KX500 PARTS LIST

Crankcase

ITEM NAME	PART NUMBER	QUANTITY
BOLT-FLANGED-SMALL (Ref # 132)	132G0650	4
BOLT-FLANGED-SMALL (Ref # 132A)	132G0660	8
ROLLER,4X8 (Ref # 610)	610A0408	1
PLATE (Ref # 13183)	13183-1182	1
SET-CRANKCASE (Ref # 14001)	14001-5258	1
BOLT,6X16 (Ref # 92002)	92002-1659	2
STUD,10X55 (Ref # 92004)	92004-1176	2
STUD,10X47 (Ref # 92004A)	92004-1223	2
FITTING,BREATHER (Ref # 92005)	92005-1127	1
SCREW,6X10 (Ref # 92009)	92009-1563	1
BUSHING,26X35X14 (Ref # 92028)	92028-131	1
CLAMP,HARNESS (Ref # 92037)	92037-1318	1
PIN,DOWEL,6.3X8X14 (Ref # 92042)	92042-007	2
BEARING-BALL,#6305 (Ref # 92045)	92045-1011	1
BEARING-BALL,6306SH2,9TC (Ref # 92045A)	92045-1027	2
BEARING-BALL,63/22T2C3 (Ref # 92045B)	92045-1134	1
BEARING-BALL (Ref # 92045C)	92045-1233	1
BEARING-BALL,608MC3 (Ref # 92045D)	92045-1305	1
BEARING-NEEDLE,HK1210 (Ref # 92046)	92046-1010	2
SEAL-OIL,TC32457 (Ref # 92049)	92049-1159	1
SEAL-OIL (Ref # 92049A)	92049-1262	1
SEAL-OIL (Ref # 92050)	92050-057	2
SEAL-OIL,TB13225.5 (Ref # 92051)	92051-005	1
GASKET,10.5X16X1 (Ref # 92065)	92065-058	1
PLUG,DRAIN (Ref # 92066)	92066-1437	1
TUBE,6X9X330 (Ref # 92190)	92190-1116	1