

2003 KX500 PARTS DIAGRAM

Clutch

E1350

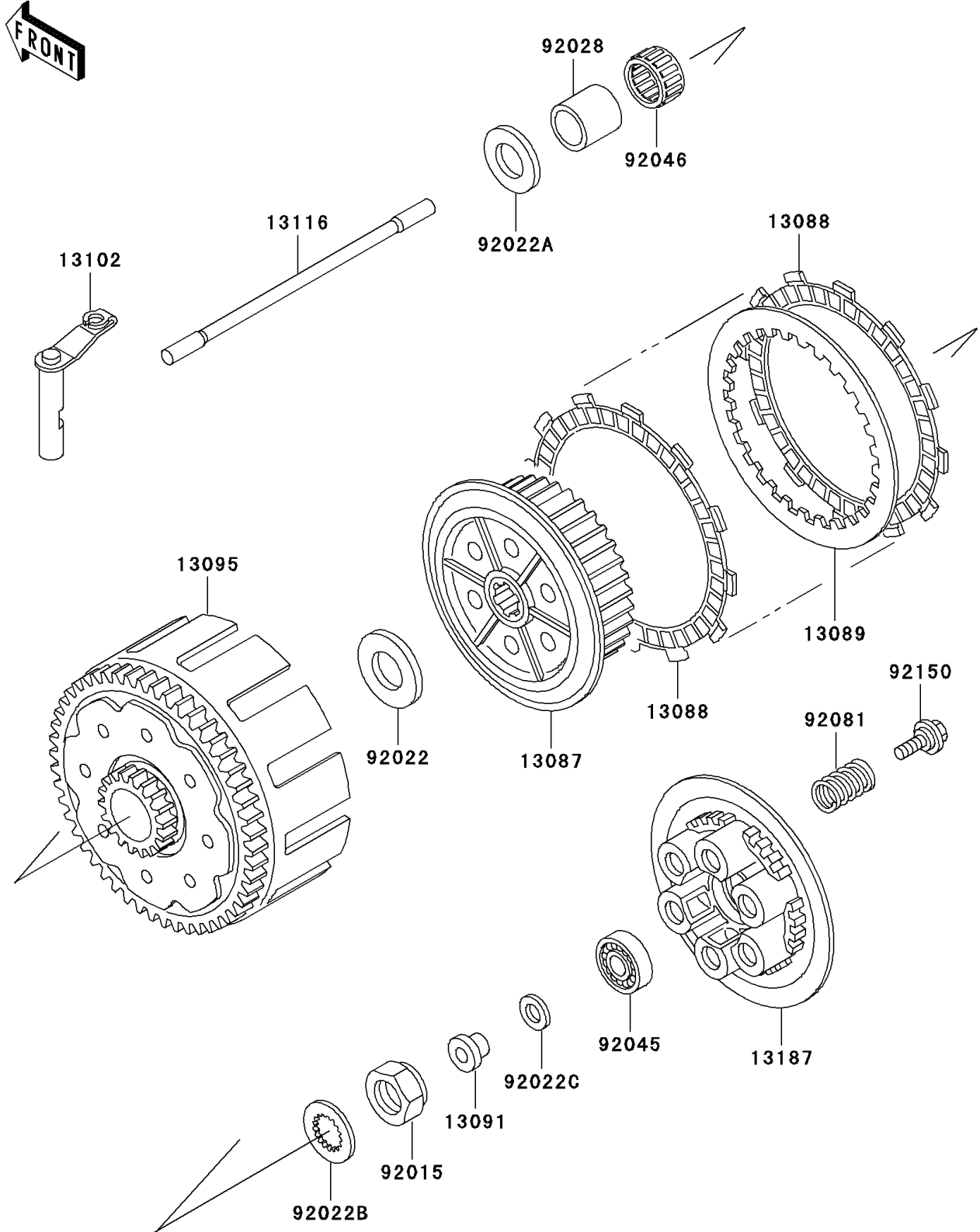

2003 KX500 PARTS LIST

Clutch

ITEM NAME	PART NUMBER	QUANTITY
HUB-CLUTCH (Ref # 13087)	13087-1138	1
PLATE-FRICTION (Ref # 13088)	13088-1114	8
PLATE-CLUTCH (Ref # 13089)	13089-1079	7
HOLDER,ROD (Ref # 13091)	13091-1582	1
HOUSING-COMP-CLUTCH (Ref # 13095)	13095-1196	1
RELEASE-COMP-CLUTCH (Ref # 13102)	13102-1107	1
ROD-PUSH,L=205 (Ref # 13116)	13116-1124	1
PLATE-CLUTCH OPERATING (Ref # 13187)	13187-1060	1
NUT,20MM (Ref # 92015)	92015-1725	1
WASHER,22.5X46X2.6 (Ref # 92022)	92022-1739	1
WASHER,22.3X38X3.0 (Ref # 92022A)	92022-1832	1
WASHER (Ref # 92022B)	92022-1942	1
WASHER,12.3X20X0.5 (Ref # 92022C)	92022-269	1
BUSHING (Ref # 92028)	92028-1551	1
BEARING-BALL,6001C3ML01 (Ref # 92045)	92045-1235	1
BEARING-NEEDLE (Ref # 92046)	92046-1193	1
SPRING,CLUTCH (Ref # 92081)	92081-1033	6
BOLT,6X22 (Ref # 92150)	92150-1489	6