

2022 VULCAN® 900 CLASSIC PARTS DIAGRAM

Ignition Switch/Locks/Reflectors

F2770

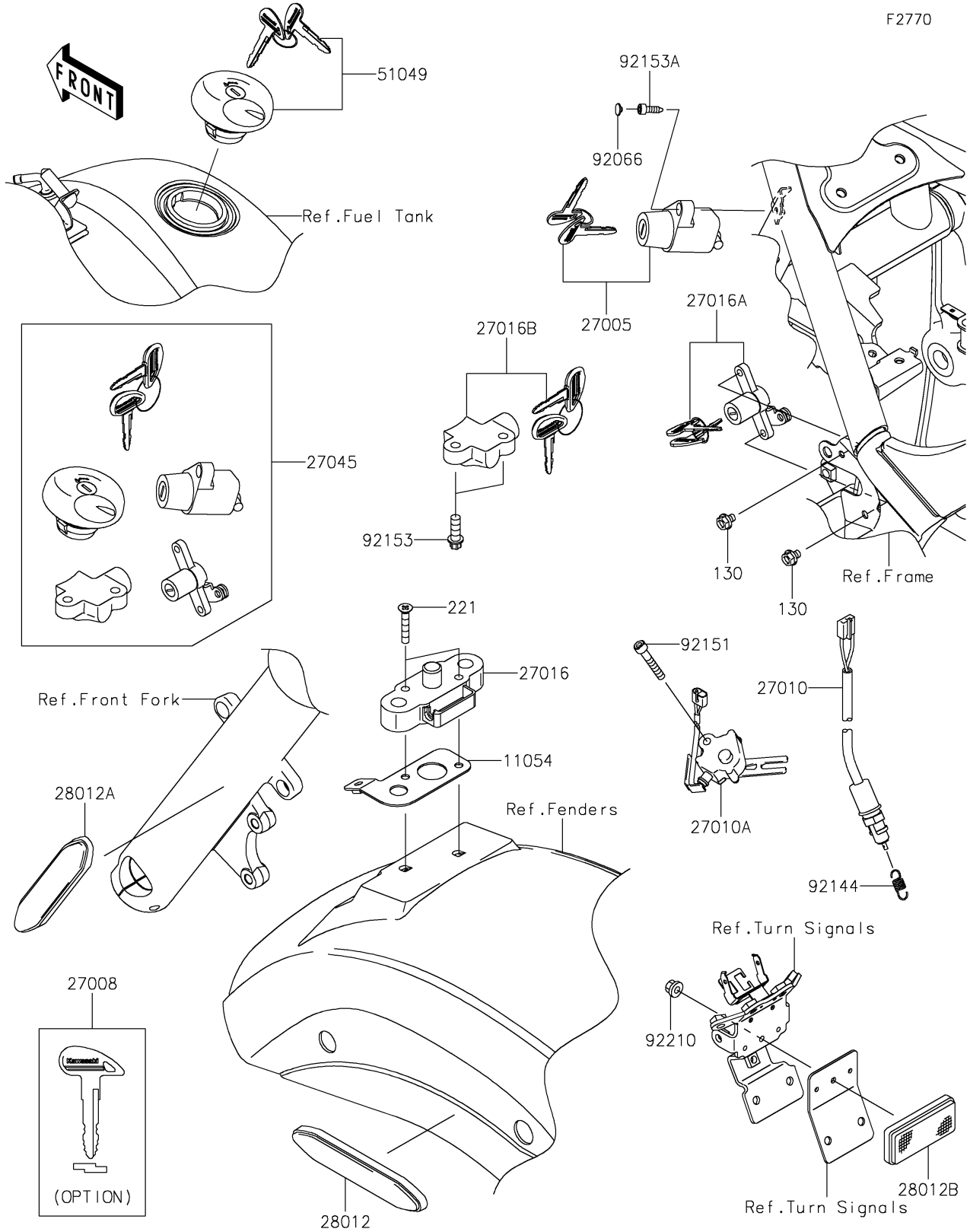

2022 VULCAN® 900 CLASSIC PARTS LIST

Ignition Switch/Locks/Reflectors

ITEM NAME	PART NUMBER	QUANTITY
-----------	-------------	----------