

1993 KX500 PARTS DIAGRAM

Muffler(s)

E1140

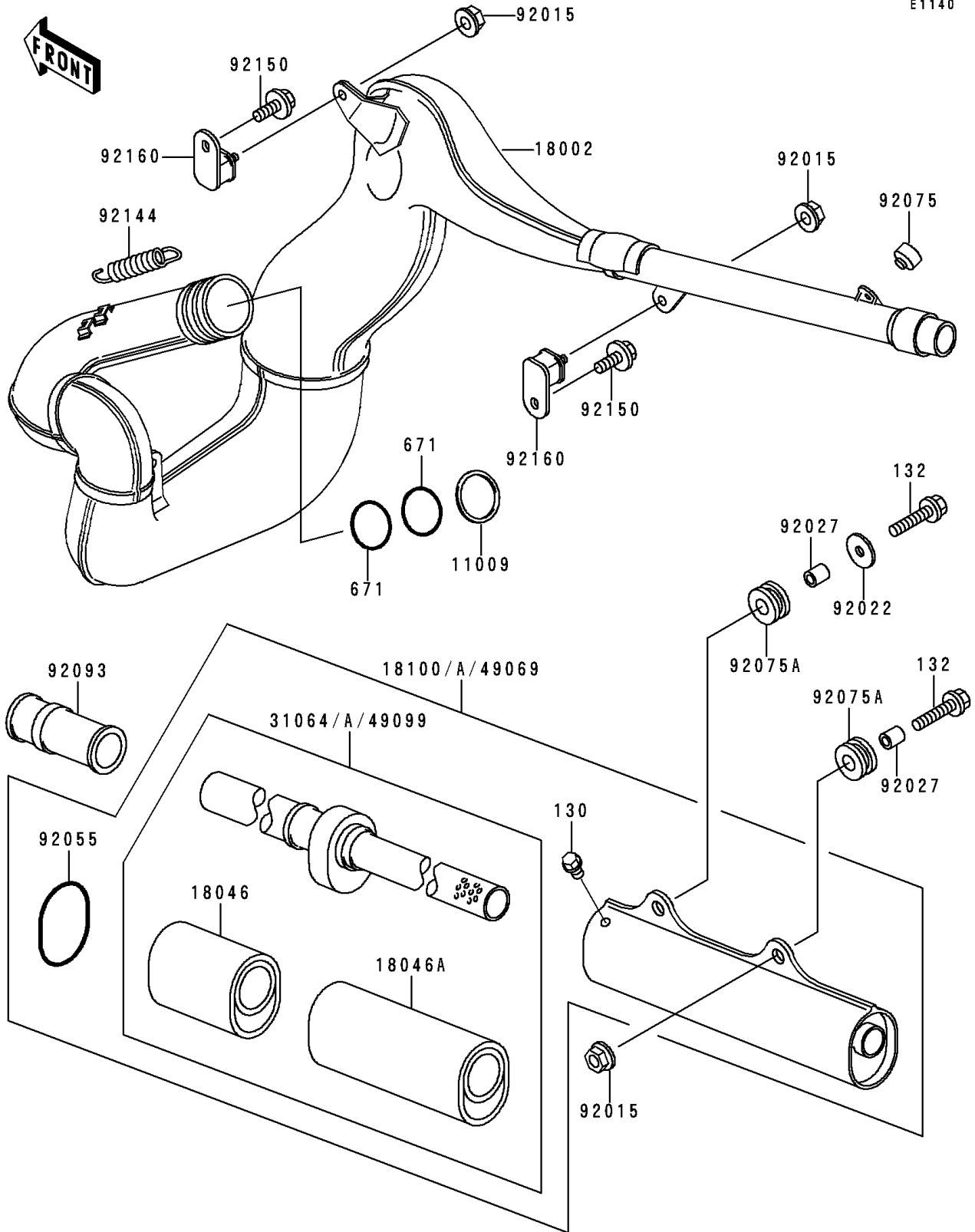

1993 KX500 PARTS LIST

Muffler(s)

ITEM NAME	PART NUMBER	QUANTITY
BOLT-FLANGED (Ref # 130)	130G0508	2
BOLT-FLANGED-SMALL (Ref # 132)	132G0630	2
O RING,50MM (Ref # 671)	671E2550	2
GASKET,EXHAUST PIPE (Ref # 11009)	11009-1949	1
BODY-COMP-MUFFLER (Ref # 18002)	18002-1862	1
WOOL,L=158 (Ref # 18046)	18046-1113	1
WOOL,L=200 (Ref # 18046A)	18046-1114	1
MUFFLER-ASSY (Ref # 49069)	49069-1120	1
BAFFLE-PIPE MUFFLER (Ref # 49099)	49099-1285	1
NUT,FLANGED,6MM (Ref # 92015)	92015-1078	5
WASHER,6.5X22X1.6 (Ref # 92022)	92022-237	1
COLLAR,6.8X10X11.5 (Ref # 92027)	92027-1210	2
RING-O,BAFFLE PIPE (Ref # 92055)	92055-1445	1
DAMPER (Ref # 92075)	92075-1598	2
DAMPER,MUFFLER FITTING (Ref # 92075A)	92075-1857	2
SEAL (Ref # 92093)	92093-1279	1
SPRING (Ref # 92144)	92144-1035	3
BOLT,6X12 (Ref # 92150)	92150-1435	3
DAMPER,MUFFLER,FR (Ref # 92160)	92160-1176	3