

# 1992 KX500 PARTS DIAGRAM

Ignition System

E1830

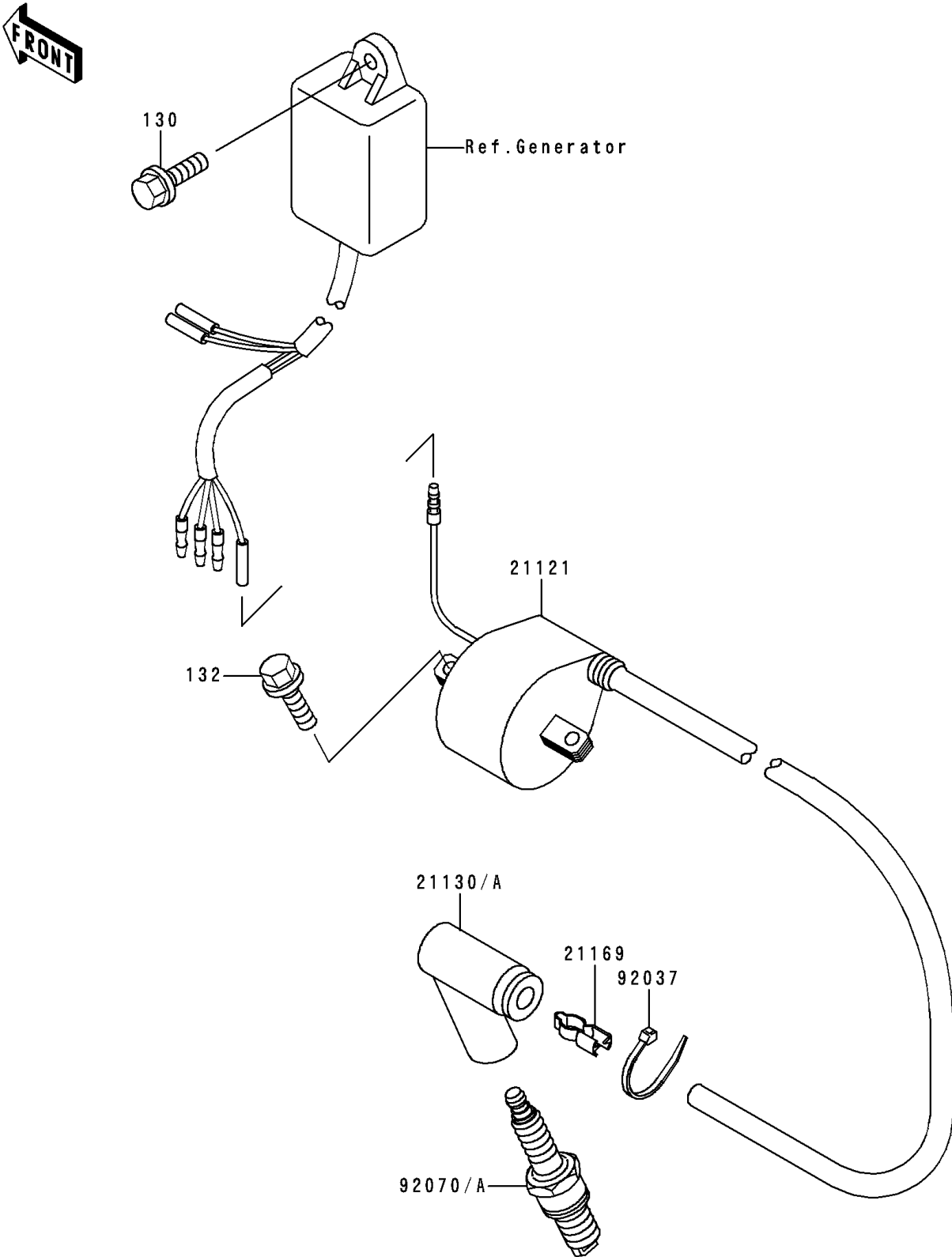

# 1992 KX500 PARTS LIST

## Ignition System

ITEM NAME	PART NUMBER	QUANTITY
BOLT-FLANGED,6X16 (Ref # 130)	130G0616	1
BOLT-FLANGED-SMALL (Ref # 132)	132G0618	2
COIL-IGNITION (Ref # 21121)	21121-1186	1
CLAMP (Ref # 92037)	92037-1173	1
CAP-SPARK PLUG (Ref # 21130)	21130-1006	1
CAP-SPARK PLUG (Ref # 21130A)	21130-1062	1
TERMINAL,PLUG CAP (Ref # 21169)	21169-001	1
PLUG-SPARK,B8EG(NGK) (Ref # 92070)	92070-1057	1
PLUG-SPARK,BR8EG(NGK) (Ref # 92070A)	92070-1064	1