

1993 KX500 PARTS DIAGRAM

Rear Brake(KX500-E4/E5/E6/E7)

F2294

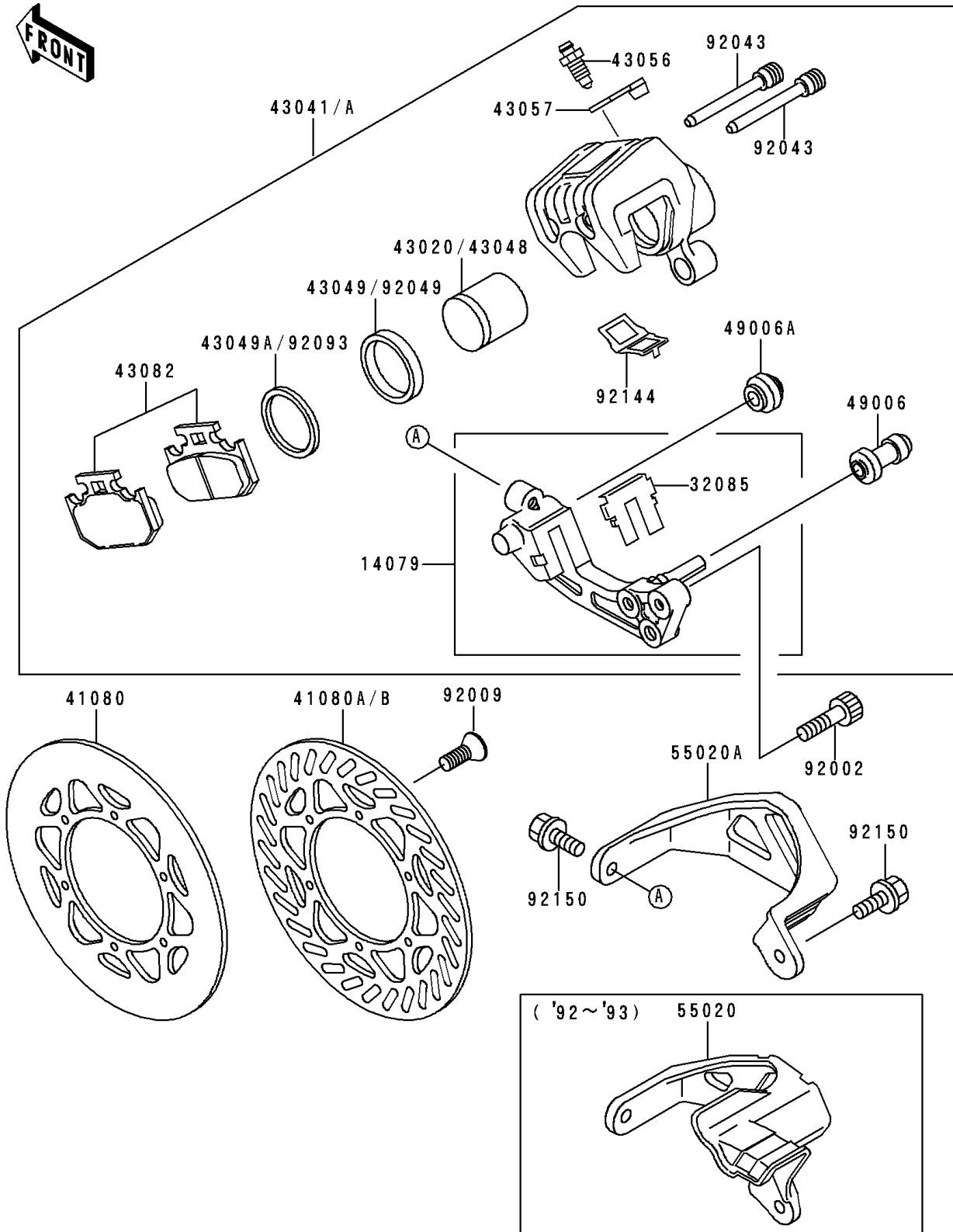

1993 KX500 PARTS LIST

Rear Brake(KX500-E4/E5/E6/E7)

ITEM NAME	PART NUMBER	QUANTITY
HOLDER-ASSY,REAR CALIPER (Ref # 14079)	14079-1070	1
STOPPER,PAD (Ref # 32085)	32085-1315	1
DISC,RR (Ref # 41080)	41080-1245	1
DISC,RR (Ref # 41080A)	41080-1294	1
PISTON-COMP-BRAKE (Ref # 43020)	43020-1099	1
CALIPER-ASSY,RR (Ref # 43041)	43041-1482	1
BREATHER-BRAKE (Ref # 43056)	43056-1055	1
CAP-BREATHER (Ref # 43057)	43057-1001	1
PAD-ASSY-BRAKE (Ref # 43082)	43082-1137	1
BOOT,CALIPER (Ref # 49006)	49006-1088	1
BOOT,CALIPER (Ref # 49006A)	49006-1242	1
GUARD,CALIPER,P.WHITE (Ref # 55020)	55020-1323-6F	1
BOLT,SOCKET,8X25 (Ref # 92002)	92002-1442	2
SCREW,6X14 (Ref # 92009)	92009-1546	6
PIN,HANGER (Ref # 92043)	92043-1416	2
SEAL-OIL,PISTON (Ref # 92049)	92049-1331	1
SEAL,PISTON (Ref # 92093)	92093-1272	1
SPRING,PAD (Ref # 92144)	92144-1364	1
BOLT,FLANGED,6X16 (Ref # 92150)	92150-1506	2