

1999 KX60 PARTS DIAGRAM

Rear Suspension

F2150

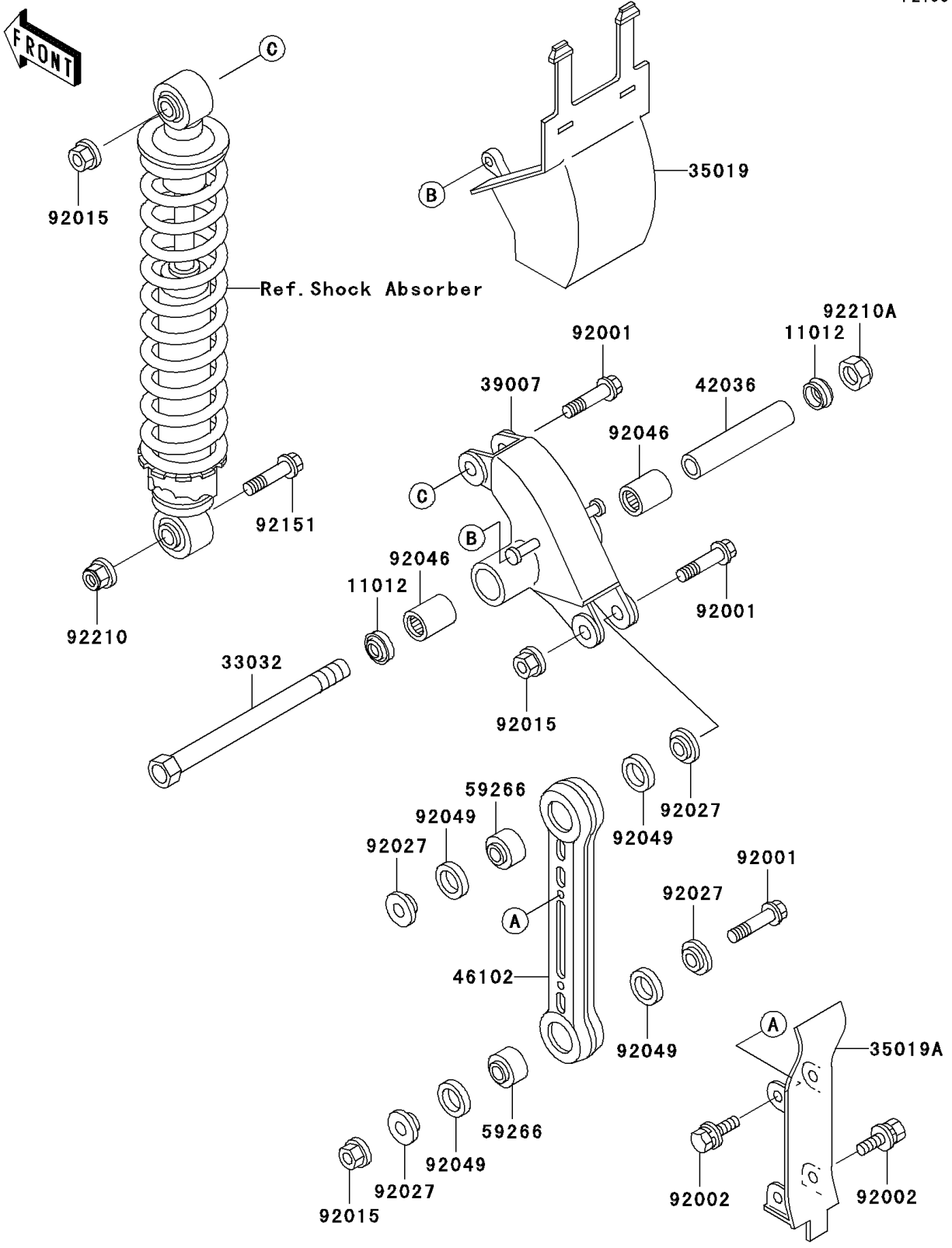

1999 KX60 PARTS LIST

Rear Suspension

ITEM NAME	PART NUMBER	QUANTITY
CAP (Ref # 11012)	11012-1263	2
SHAFT-SUSPENSION ARM,L=168 (Ref # 33032)	33032-1032	1
FLAP,SUSPENSION ARM (Ref # 35019)	35019-1046	1
FLAP,SUSPENSION ROD (Ref # 35019A)	35019-1137	1
ARM-SUSP,UNI-TRAK (Ref # 39007)	39007-1062	1
SLEEVE,SUSPENSION ARM,L=86 (Ref # 42036)	42036-1068	1
ROD,SUSPENSION (Ref # 46102)	46102-1125	1
JOINT-BALL (Ref # 59266)	59266-1011	2
BOLT,FLANGED,10X42 (Ref # 92001)	92001-1711	3
BOLT,6X14 (Ref # 92002)	92002-1133	4
NUT,FLANGED,10MM (Ref # 92015)	92015-1415	3
COLLAR,SUSPENSION ROD (Ref # 92027)	92027-1496	4
BEARING-NEEDLE (Ref # 92046)	92046-1046	2
SEAL-OIL (Ref # 92049)	92049-1098	4
BOLT,FLANGED,10X41 (Ref # 92151)	92151-1831	1
NUT,LOCK,FLANGED,10MM (Ref # 92210)	92210-1080	1
NUT,LOCK,12MM (Ref # 92210A)	92210-1249	1