

# 1991 KX60 PARTS DIAGRAM

Gear Change Mechanism

E1370

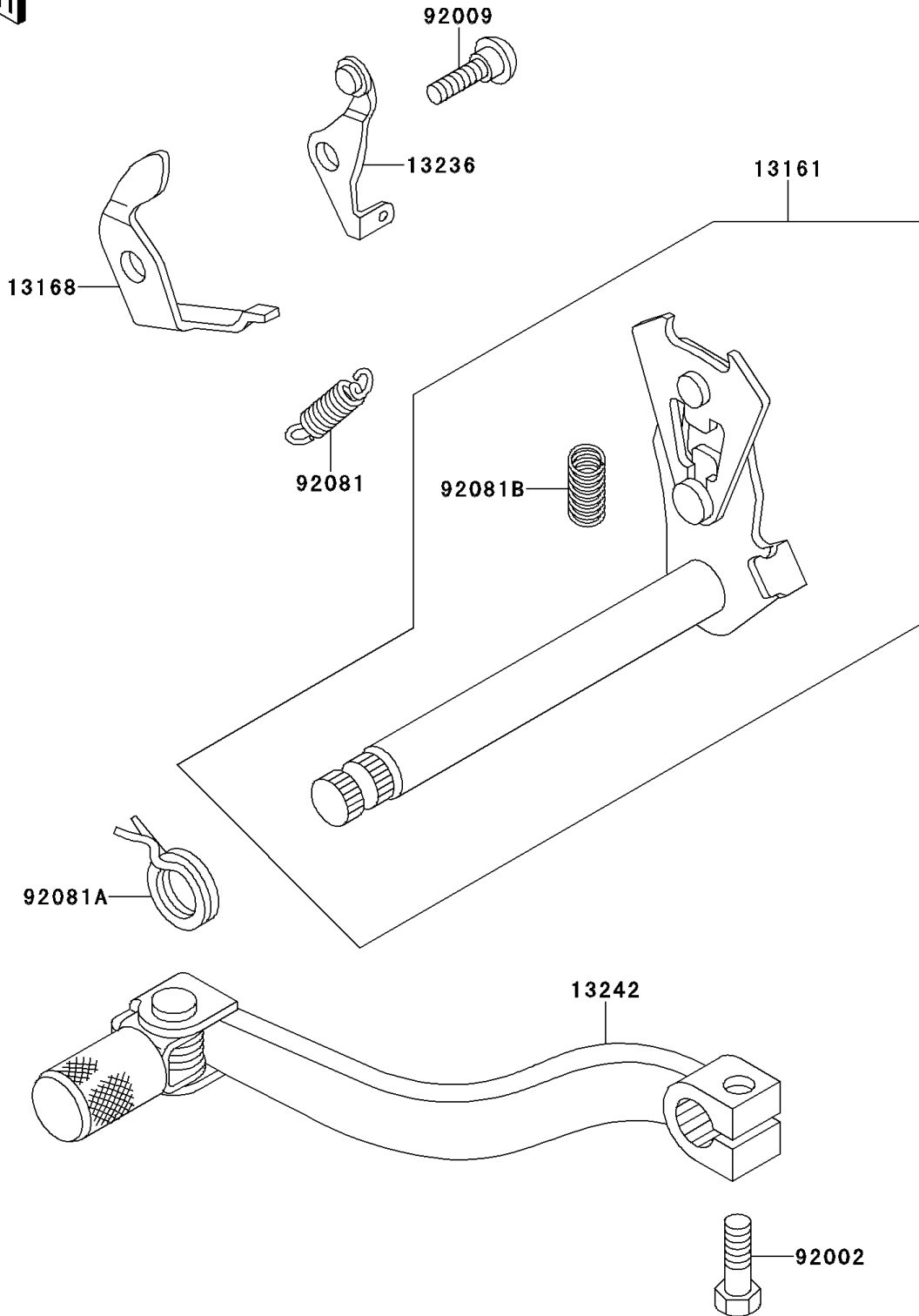

# 1991 KX60 PARTS LIST

## Gear Change Mechanism

ITEM NAME	PART NUMBER	QUANTITY
LEVER-COMP-CHANGE SHAFT (Ref # 13161)	13161-1108	1
LEVER,GEAR SET (Ref # 13168)	13168-1069	1
LEVER-COMP,CHANGE DRUM (Ref # 13236)	13236-1026	1
LEVER-ASSY-CHANGE,PEDAL (Ref # 13242)	13242-1210	1
BOLT,6X20 (Ref # 92002)	92002-1237	1
SCREW,CHANGE LEVER (Ref # 92009)	92009-1102	1
SPRING,CHANGE LEVER (Ref # 92081)	92081-1109	1
SPRING,TENSION (Ref # 92081A)	92081-1129	1
SPRING,CHANGE LEVER (Ref # 92081B)	92081-1275	1