

1990 KX60 PARTS DIAGRAM

Crankcase

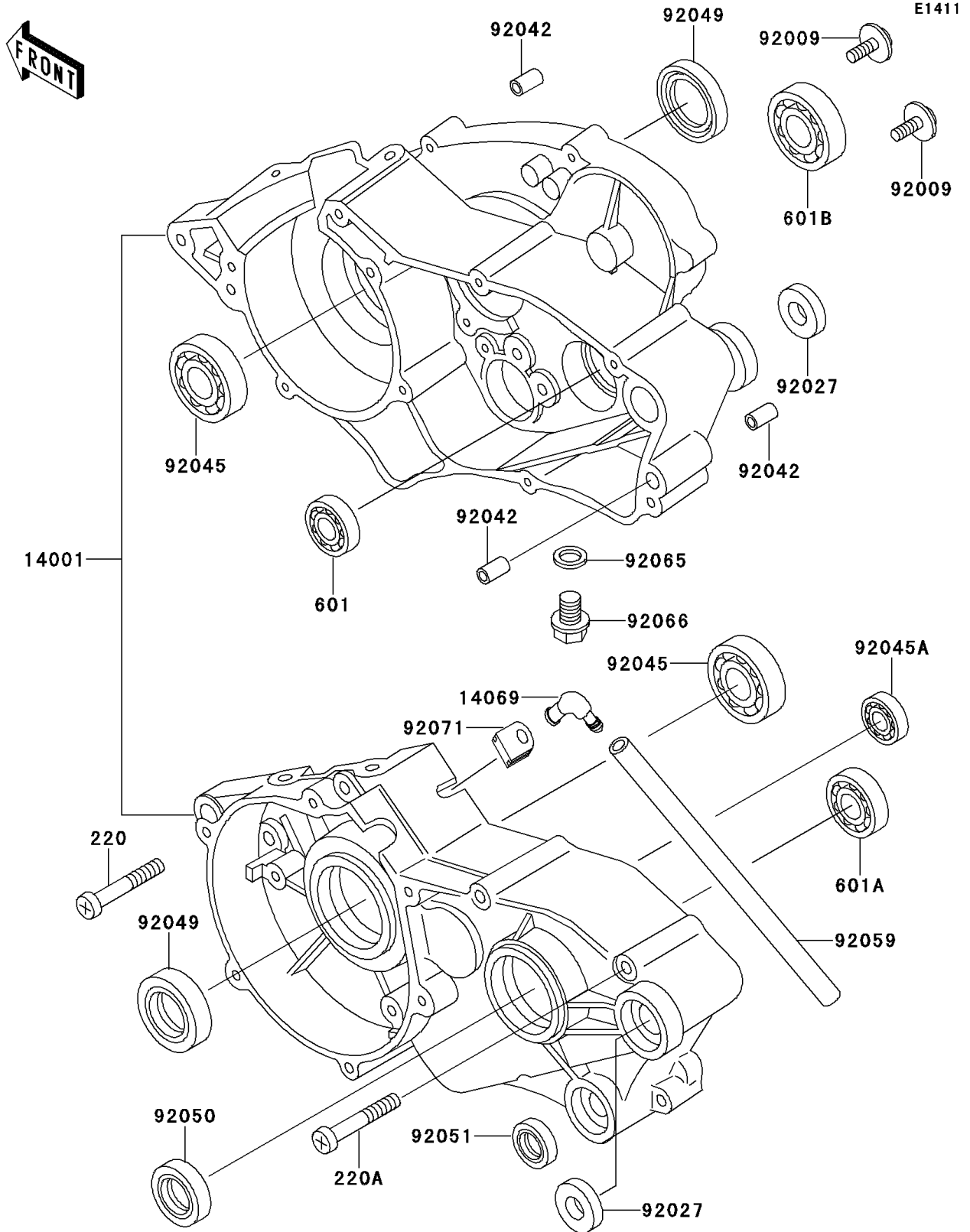

1990 KX60 PARTS LIST

Crankcase

ITEM NAME	PART NUMBER	QUANTITY
SCREW-PAN-CROS,6X35 (Ref # 220)	220B0635	8
SCREW-PAN-CROS,6X60 (Ref # 220A)	220B0660	1
BEARING-BALL (Ref # 601)	601A6002	1
BEARING-BALL,#6004 (Ref # 601A)	601A6004	1
BEARING-BALL,#6203 (Ref # 601B)	601A6203	1
SET-CRANKCASE (Ref # 14001)	14001-5151	1
BREATHER,CRANKCASE (Ref # 14069)	14069-002	1
SCREW,6X15 (Ref # 92009)	92009-1103	2
COLLAR,12.1X26X6 (Ref # 92027)	92027-1744	2
PIN,DOWEL,6.3X8X14 (Ref # 92042)	92042-007	4
BEARING-BALL,R-6304C3 (Ref # 92045)	92045-1059	2
BEARING-BALL,6001C3ML01 (Ref # 92045A)	92045-1235	1
SEAL-OIL,SD20407GS (Ref # 92049)	92049-1188	2
SEAL-OIL,SC25376 (Ref # 92050)	92050-013	1
SEAL-OIL,TB13225.5 (Ref # 92051)	92051-005	1
TUBE,6X9X280 (Ref # 92059)	92059-1074	1
GASKET,10.5X16X1,DRAIN PLUG (Ref # 92065)	92065-058	1
PLUG,DRAIN (Ref # 92066)	92066-1241	1
GROMMET,BREATHER (Ref # 92071)	92071-042	1