

1992 KX60 PARTS DIAGRAM

Carburetor

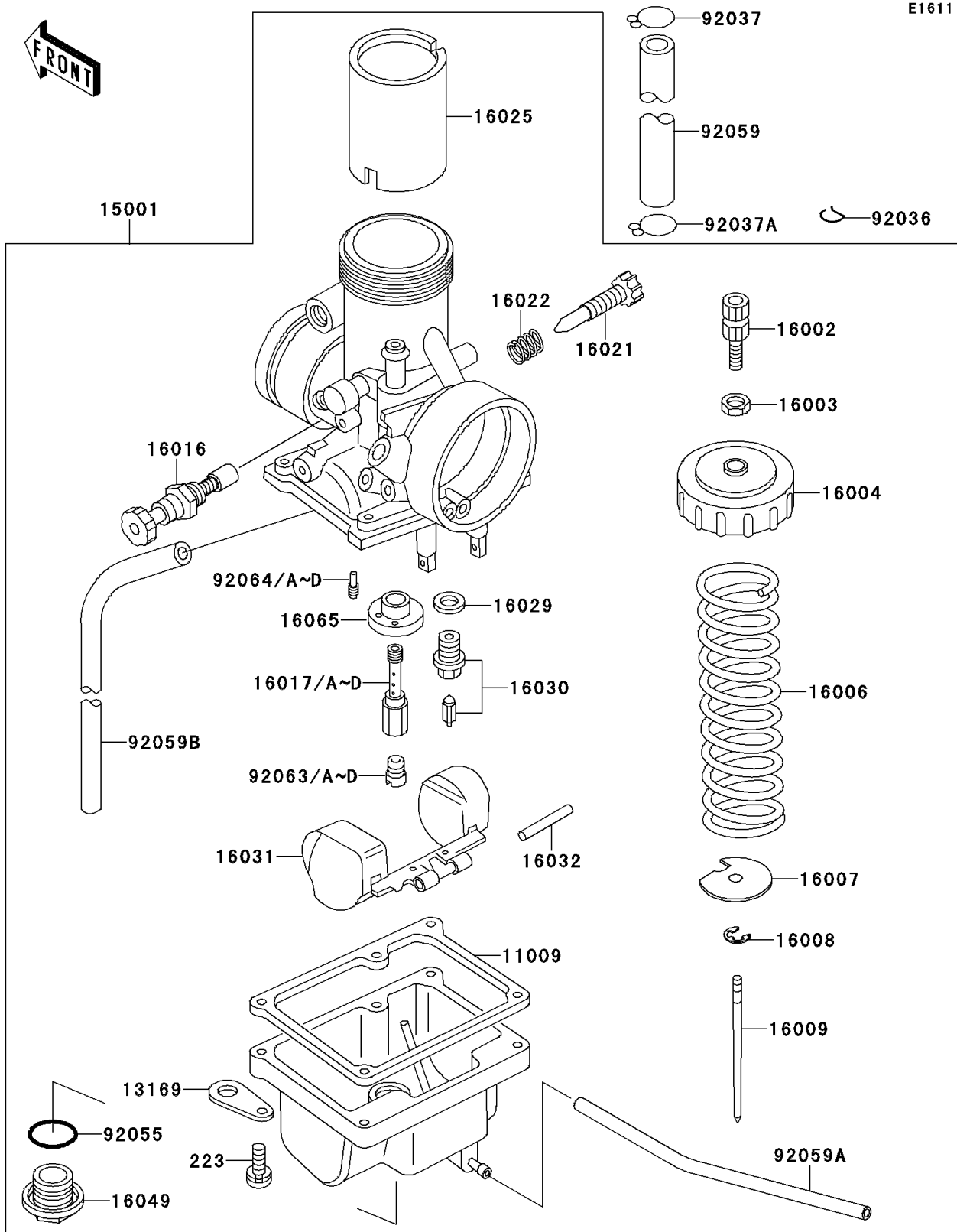

E1611

1992 KX60 PARTS LIST

Carburetor

ITEM NAME	PART NUMBER	QUANTITY
GASKET,FLOAT CHAMBER (Ref # 11009)	11009-1147	1
PLATE,TUBE CLAMP (Ref # 13169)	13169-1226	1
CARBURETOR-ASSY (Ref # 15001)	15001-1384	1
ADJUSTER-CABLE (Ref # 16002)	16002-011	1
NUT,ADJUST LOCK (Ref # 16003)	16003-006	1
CAP-CHAMBER (Ref # 16004)	16004-025	1
SPRING,THROTTLE VALVE (Ref # 16006)	16006-023	1
SEAT-SPRING,THROTTLE VALVE (Ref # 16007)	16007-023	1
CLAMP,E-TYPE (Ref # 16008)	16008-010	1
NEEDLE-JET,5I14 (Ref # 16009)	16009-1220	1
PLUNGER,STARTER (Ref # 16016)	16016-1052	1
JET-NEEDLE,N-8 (Ref # 16017)	16017-1215	1
JET-NEEDLE,O-0 (Ref # 16017A)	16017-1216	1
JET-NEEDLE,O-2 (Ref # 16017B)	16017-1217	1
JET-NEEDLE,N-6 (Ref # 16017C)	16017-1259	1
JET-NEEDLE,N-4 (Ref # 16017D)	16017-1268	1
SCREW-THROTTLE STOP (Ref # 16021)	16021-1104	1
SPRING,THROTTLE STOP SCREW (Ref # 16022)	16022-005	1
VALVE-THROTTLE,CA2.0 (Ref # 16025)	16025-1107	1
GASKET,FLOAT VALVE SEAT (Ref # 16029)	16029-004	1
VALVE-FLOAT,2.5 (Ref # 16030)	16030-005	1
FLOAT (Ref # 16031)	16031-1005	1
PIN,FLOAT (Ref # 16032)	16032-003	1
COVER-MAIN JET (Ref # 16049)	16049-1001	1
HOLDER,JET NEEDLE (Ref # 16065)	16065-1020	1
RING-SNAP (Ref # 92036)	92036-018	1
CLAMP,TUBE (Ref # 92037)	92037-147	1
CLAMP (Ref # 92037A)	92037-1712	1
RING-O,MAIN JET COVER (Ref # 92055)	92055-1061	1

1992 KX60 PARTS LIST

Carburetor

ITEM NAME	PART NUMBER	QUANTITY
TUBE,5.3X10.5X130 (Ref # 92059)	92059-1393	1
TUBE,3X5X160 (Ref # 92059A)	92059-1395	1
TUBE,3X5X270 (Ref # 92059B)	92059-1396	1
JET-MAIN,#180 (Ref # 92063)	92063-020	1
JET-MAIN,#190 (Ref # 92063A)	92063-021	1
JET-MAIN,#200 (Ref # 92063B)	92063-022	1
SCREW-PAN-WS-CROS (Ref # 223)	223B0416	4
JET-MAIN,#210 (Ref # 92063C)	92063-023	1
JET-MAIN,#220 (Ref # 92063D)	92063-024	1
JET-PILOT,#35 (Ref # 92064)	92064-1023	1
JET-PILOT,#30 (Ref # 92064A)	92064-1030	1
JET-PILOT,#25 (Ref # 92064B)	92064-1038	1
JET-PILOT,#40 (Ref # 92064C)	92064-1104	1
JET-PILOT,#20 (Ref # 92064D)	92064-1110	1