

# 2022 Vulcan® S ABS CAFE PARTS DIAGRAM

Front Fender(s)

F2171

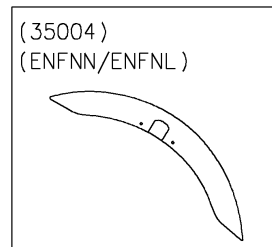
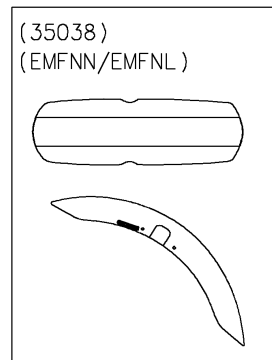
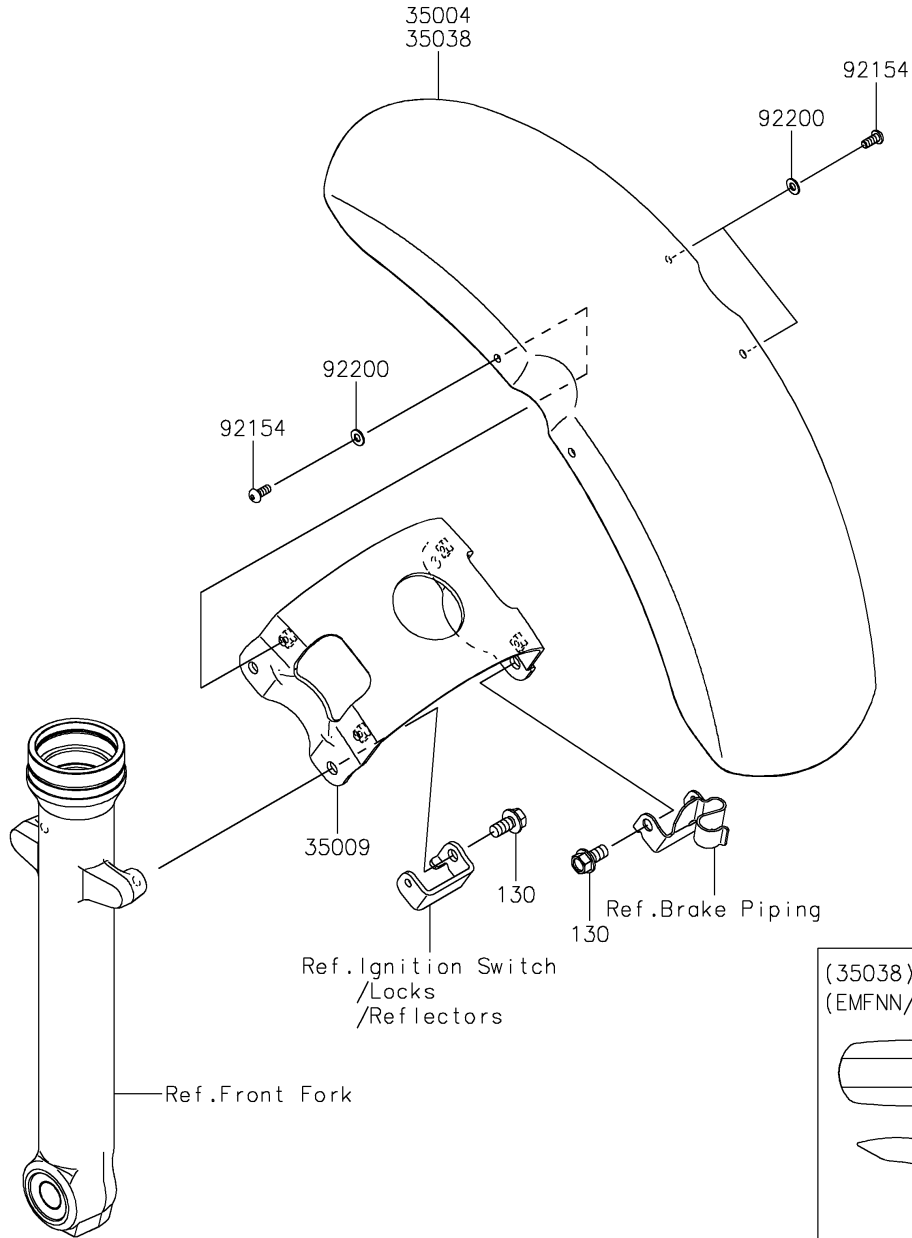

## 2022 Vulcan® S ABS CAFE PARTS LIST

### Front Fender(s)

ITEM NAME	PART NUMBER	QUANTITY
FENDER-FRONT,EBONY (Ref # 35004)	35004-0341-H8	1
BRACE (Ref # 35009)	35009-0039	1
FENDER-FRONT,EBONY (Ref # 35038)	35038-5158-H8	1
BOLT,SOCKET,5X12 (Ref # 92154)	92154-1471	4
WASHER,5.3X11X1 (Ref # 92200)	92200-0973	4
BOLT-FLANGED,8X16 (Ref # 130)	130BA0816	4