

2022 KLX® 230R S PARTS DIAGRAM

Fuel Tank(CN,US)

F2410

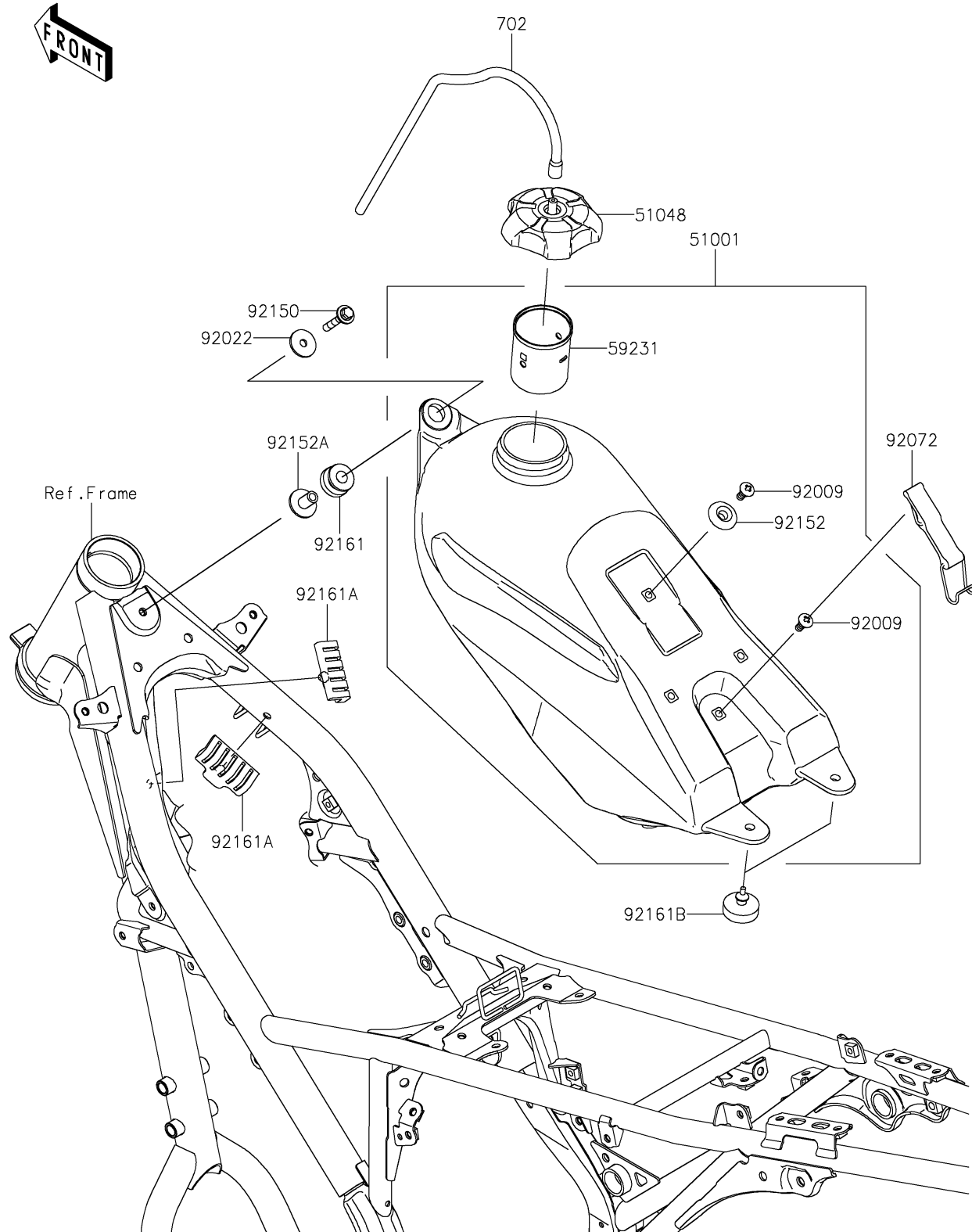

2022 KLX® 230R S PARTS LIST

Fuel Tank(CN,US)

ITEM NAME	PART NUMBER	QUANTITY
TANK-COMP-FUEL (Ref # 51001)	51001-0875	1
TANK-COMP-FUEL (Ref # 51001)	51001-0875	1
CAP-ASSY-TANK (Ref # 51048)	51048-0576	1
CAP-ASSY-TANK (Ref # 51048)	51048-0576	1
FILLER (Ref # 59231)	59231-0042	1
FILLER (Ref # 59231)	59231-0042	1
SCREW,6MM (Ref # 92009)	92009-1971	2
SCREW,6MM (Ref # 92009)	92009-1971	2
WASHER,6.5X24X2 (Ref # 92022)	92022-1690	1
WASHER,6.5X24X2 (Ref # 92022)	92022-1690	1
BAND,FUEL TANK (Ref # 92072)	92072-0842	1
BAND,FUEL TANK (Ref # 92072)	92072-0842	1
BOLT,FLANGED,6X35 (Ref # 92150)	92150-1527	1
BOLT,FLANGED,6X35 (Ref # 92150)	92150-1527	1
COLLAR (Ref # 92152)	92152-0569	1
COLLAR (Ref # 92152)	92152-0569	1
COLLAR,6.8X10X16 (Ref # 92152A)	92152-2666	1
COLLAR,6.8X10X16 (Ref # 92152A)	92152-2666	1
DAMPER,FUEL TANK,FR (Ref # 92161)	92161-1392	1
DAMPER,FUEL TANK,FR (Ref # 92161)	92161-1392	1
DAMPER (Ref # 92161A)	92161-2166	2
DAMPER (Ref # 92161A)	92161-2166	2
DAMPER (Ref # 92161B)	92161-2203	2
DAMPER (Ref # 92161B)	92161-2203	2
TUBE-RUBBER,5X8X400 (Ref # 702)	702A05400	1
TUBE-RUBBER,5X8X400 (Ref # 702)	702A05400	1