

2007 Vulcan 1600 Nomad PARTS DIAGRAM

Ignition Switch/Locks/Reflectors

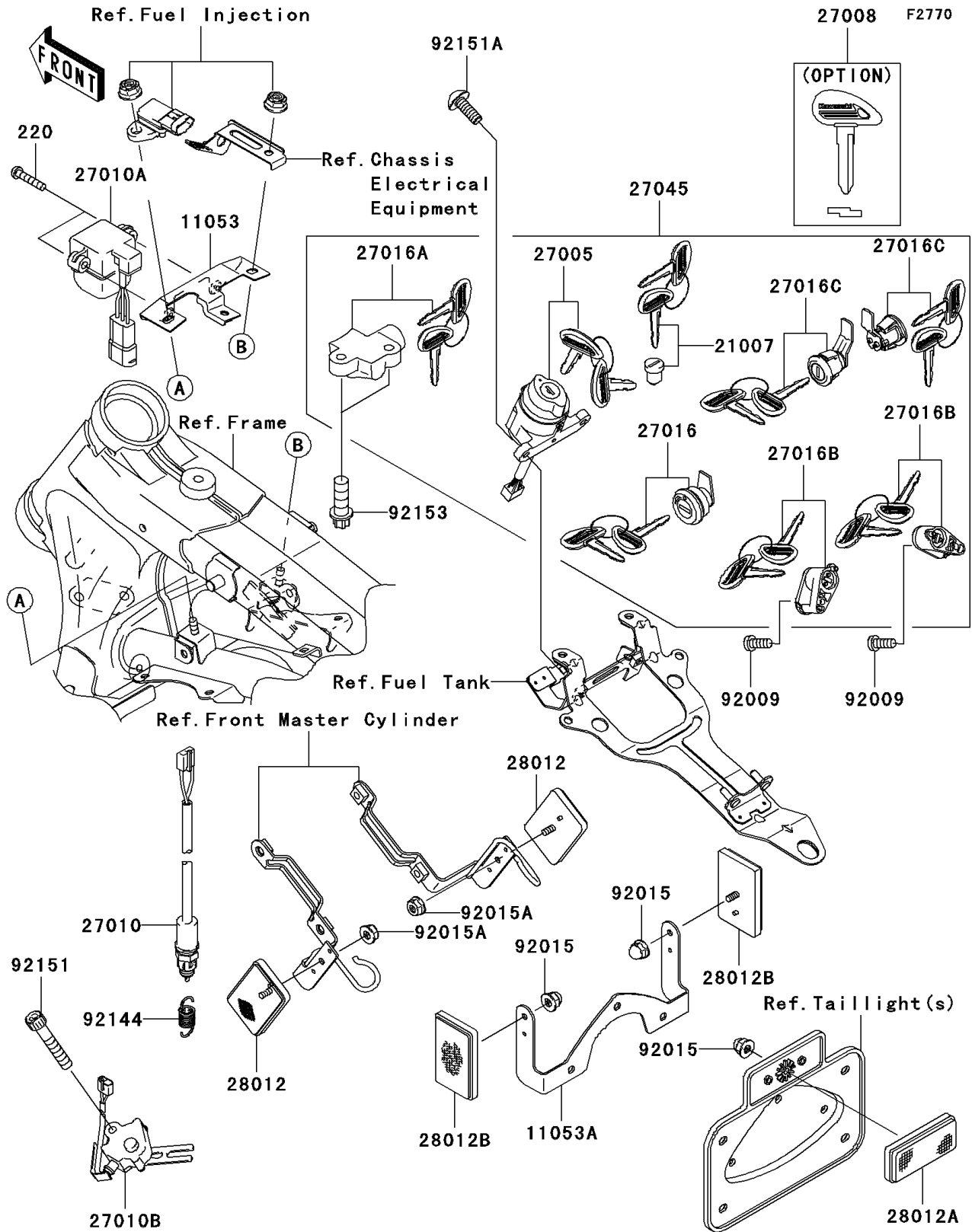

2007 Vulcan 1600 Nomad PARTS LIST

Ignition Switch/Locks/Reflectors

ITEM NAME	PART NUMBER	QUANTITY
SCREW-PAN-CROS,4X20 (Ref # 220)	220C0420	2
BRACKET,DOWN SENSOR (Ref # 11053)	11053-0261	1
BRACKET,REFLECTOR,RR (Ref # 11053A)	11053-1669	1
ROTOR,LOCK,TANK CAP (Ref # 21007)	21007-5053	1
SWITCH-ASSY-IGNITION (Ref # 27005)	27005-0001	1
KEY-LOCK,BLANK (Ref # 27008)	27008-1211	1
SWITCH,REAR BRAKE (Ref # 27010)	27010-1412	1
SWITCH,DOWN SENSOR (Ref # 27010A)	27010-1416	1
SWITCH,SIDE STAND (Ref # 27010B)	27010-1470	1
LOCK-ASSY,LID (Ref # 27016)	27016-5279	1
LOCK-ASSY,STEERING (Ref # 27016A)	27016-5298	1
LOCK-ASSY,HELMET (Ref # 27016B)	27016-5311	2
LOCK-ASSY,SIDE BAG (Ref # 27016C)	27016-5325	2
SWITCH-ASSY (Ref # 27045)	27045-5285	1
REFLECTOR-REFLEX,FR (Ref # 28012)	28012-1009	2
REFLECTOR-REFLEX (Ref # 28012A)	28012-1077	1
REFLECTOR-REFLEX (Ref # 28012B)	28012-1088	2
SCREW,5X12 (Ref # 92009)	92009-1296	2
NUT,LOCK,FLANGE CAP,5MM (Ref # 92015)	92015-1263	3
NUT,FLANGED,5MM (Ref # 92015A)	92015-1656	2
SPRING,REAR BRAKE SWITCH (Ref # 92144)	92144-1141	1
BOLT,SOCKET,6X35 (Ref # 92151)	92151-1390	1
BOLT,SOCKET,6X16 (Ref # 92151A)	92151-1751	2
BOLT,TORX,8X22 (Ref # 92153)	92153-1273	2