

# 1995 KX80 PARTS DIAGRAM

Clutch

E1350

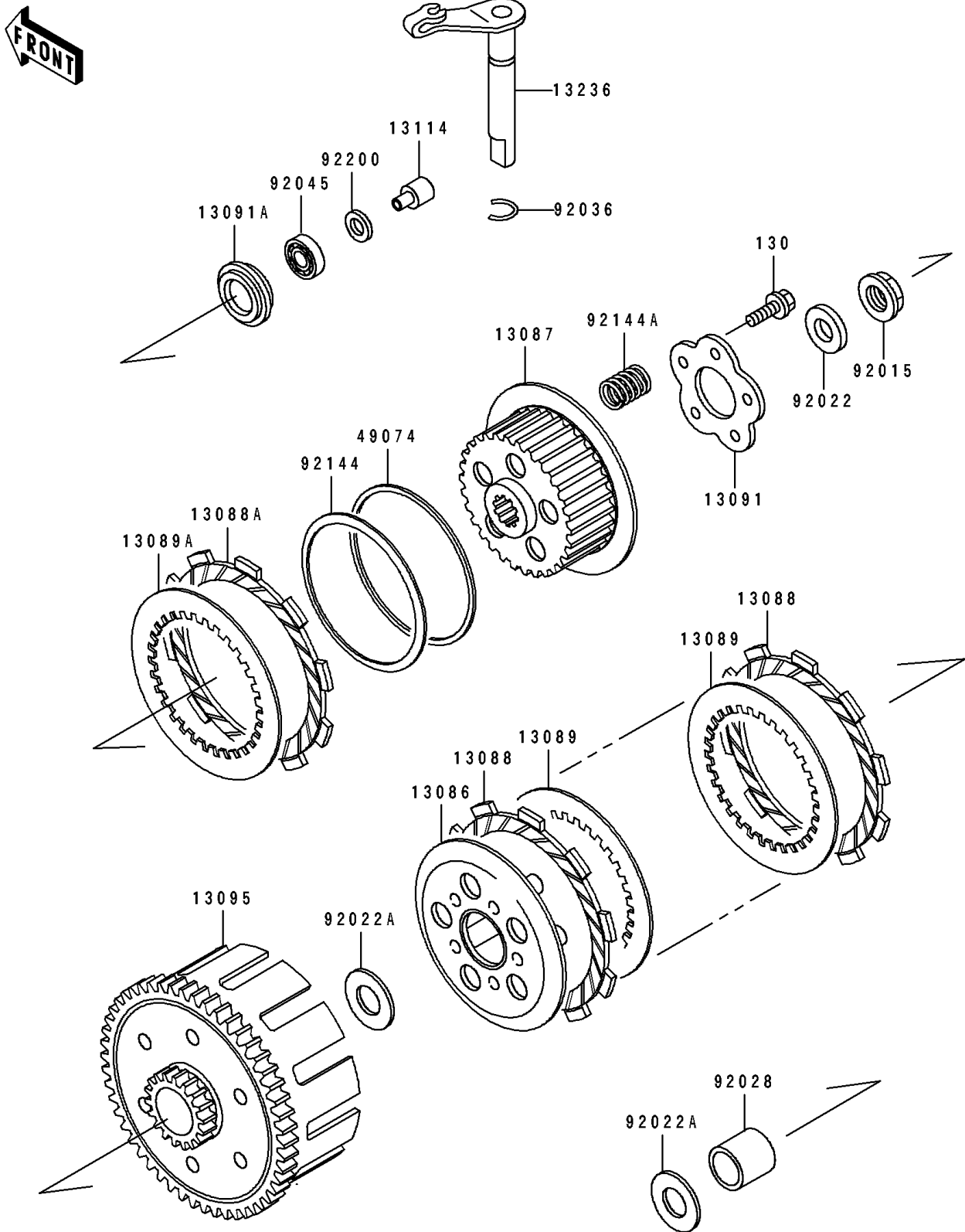

# 1995 KX80 PARTS LIST

## Clutch

ITEM NAME	PART NUMBER	QUANTITY
WHEEL-CLUTCH (Ref # 13086)	13086-1058	1
HUB-CLUTCH (Ref # 13087)	13087-1090	1
PLATE-FRICTION (Ref # 13088)	13088-1070	6
PLATE-FRICTION (Ref # 13088A)	13088-1082	1
PLATE-CLUTCH,STEEL (Ref # 13089)	13089-1009	5
PLATE-CLUTCH (Ref # 13089A)	13089-1101	1
HOLDER,CLUTCH (Ref # 13091)	13091-1324	1
HOLDER (Ref # 13091A)	13091-1517	1
HOUSING-COMP-CLUTCH (Ref # 13095)	13095-1165	1
PUSHER-CLUTCH (Ref # 13114)	13114-1053	1
LEVER-COMP,RELEASE (Ref # 13236)	13236-1158	1
PLATE-THRUST (Ref # 49074)	49074-1052	1
NUT (Ref # 92015)	92015-1706	1
WASHER (Ref # 92022)	92022-1831	1
WASHER,17.3X28X1 (Ref # 92022A)	92022-255	2
BUSHING,17X22X21.1 (Ref # 92028)	92028-1149	1
RING-SNAP (Ref # 92036)	92036-023	1
BEARING-BALL (Ref # 92045)	92045-1236	1
SPRING (Ref # 92144)	92144-1370	1
SPRING,CLUTCH (Ref # 92144A)	92144-1384	5
WASHER,7X12.5X0.8 (Ref # 92200)	92200-1197	AR
BOLT-FLANGED (Ref # 130)	130P0520	5