

1995 KX80 PARTS DIAGRAM

Swingarm

F2141

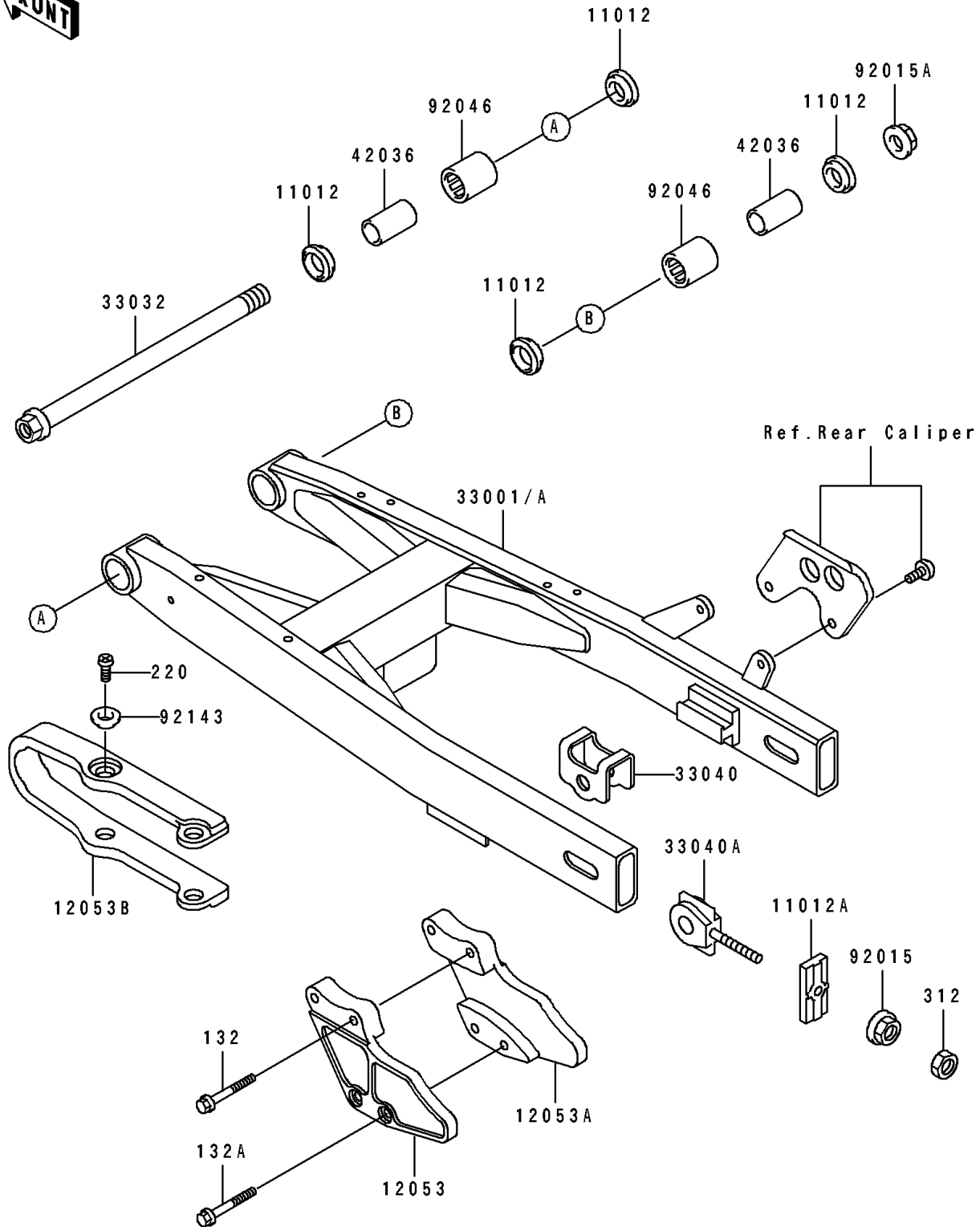

1995 KX80 PARTS LIST

Swingarm

ITEM NAME	PART NUMBER	QUANTITY
CAP (Ref # 11012)	11012-1263	4
CAP,CHAIN ADJUSTER (Ref # 11012A)	11012-1601	2
GUIDE-CHAIN,RR,LH (Ref # 12053)	12053-1203	1
GUIDE-CHAIN,RR,RH (Ref # 12053A)	12053-1204	1
GUIDE-CHAIN,DRIVE,FR (Ref # 12053B)	12053-1277	1
ARM-COMP-SWING,SILVER NO.35 (Ref # 33001)	33001-1390-TX	1
SHAFT-SWING ARM (Ref # 33032)	33032-1161	1
ADJUSTER-CHAIN,OUTSIDE (Ref # 33040)	33040-1066	2
ADJUSTER-CHAIN,INSIDE (Ref # 33040A)	33040-1081	2
SLEEVE,SWING ARM,L=34 (Ref # 42036)	42036-1067	2
NUT,FLANGED,6MM (Ref # 92015)	92015-1078	2
NUT,LOCK,12MM (Ref # 92015A)	92015-1774	1
BEARING-NEEDLE (Ref # 92046)	92046-1046	2
COLLAR (Ref # 92143)	92143-1156	4
BOLT-FLANGED-SMALL (Ref # 132)	132G0640	2
BOLT-FLANGED-SMALL (Ref # 132A)	132G0645	2
SCREW-PAN-CROS,6X8 (Ref # 220)	220B0608	4
NUT-HEX,6MM (Ref # 312)	312B0600	2