

2007 Vulcan 1600 Nomad PARTS DIAGRAM

Cowling

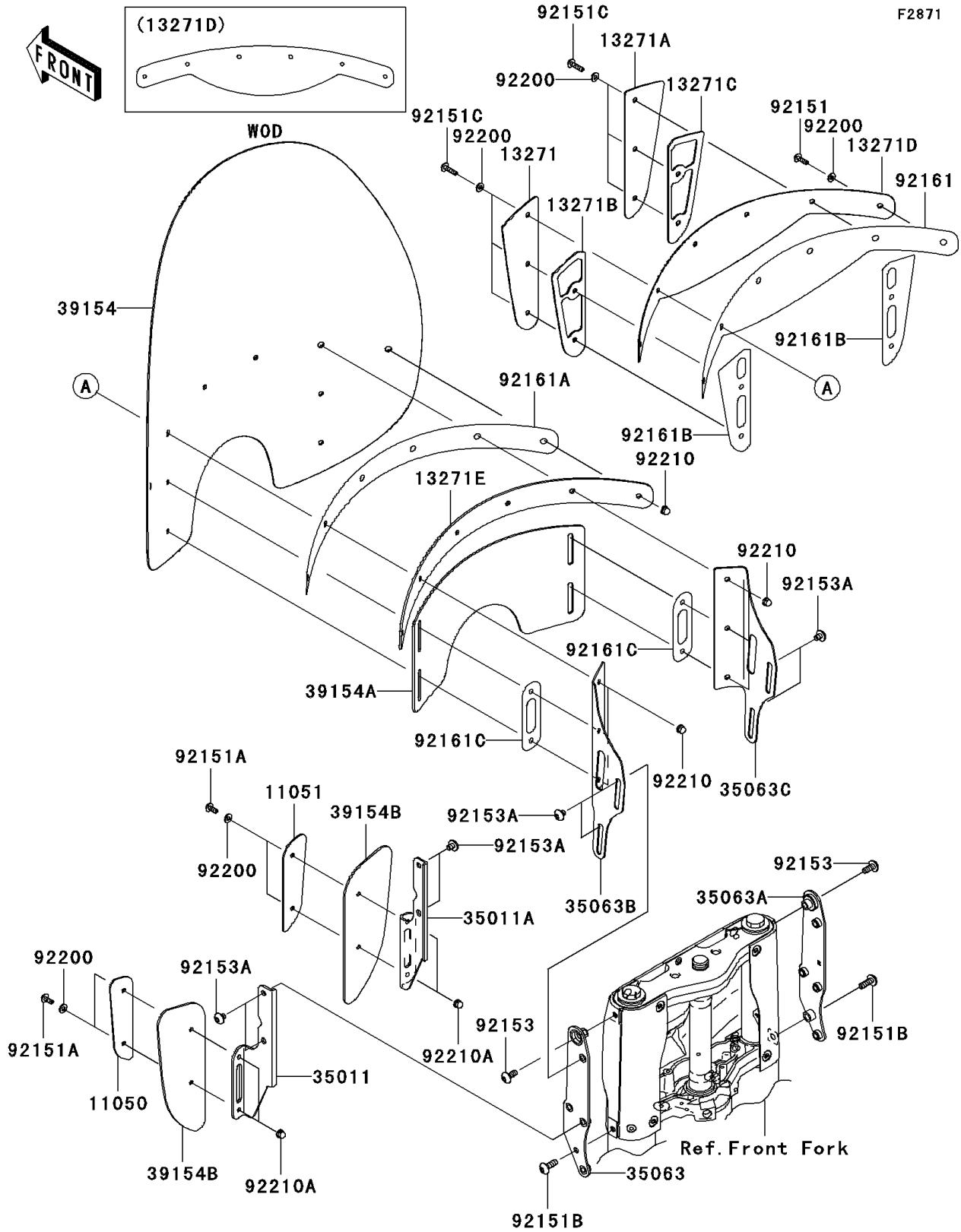

2007 Vulcan 1600 Nomad PARTS LIST

Cowling

ITEM NAME	PART NUMBER	QUANTITY
BRACKET,DEFLECTOR,LH (Ref # 11050)	11050-1750	1
BRACKET,DEFLECTOR,RH (Ref # 11051)	11051-1061	1
PLATE,WINDSHIELD,LH,OUTER (Ref # 13271)	13271-0570	1
PLATE,WINDSHIELD,RH,OUTER (Ref # 13271A)	13271-0571	1
PLATE,WINDSHIELD,LH,INNER (Ref # 13271B)	13271-0572	1
PLATE,WINDSHIELD,RH,INNER (Ref # 13271C)	13271-0573	1
PLATE,WINDSHIELD,CNT,OUTER (Ref # 13271D)	13271-1089	1
PLATE,WINDSHIELD,CNT,INNER (Ref # 13271E)	13271-1090	1
STAY,DEFLECTOR,LH (Ref # 35011)	35011-1916	1
STAY,DEFLECTOR,RH (Ref # 35011A)	35011-1917	1
STAY,MAIN,LH (Ref # 35063)	35063-0209	1
STAY,MAIN,RH (Ref # 35063A)	35063-0210	1
STAY,WINDSHIELD,LH (Ref # 35063B)	35063-0213	1
STAY,WINDSHIELD,RH (Ref # 35063C)	35063-0214	1
WINDSHIELD,MAIN (Ref # 39154)	39154-0012	1
WINDSHIELD,SUB (Ref # 39154A)	39154-0013	1
WINDSHIELD,DEFLECTOR (Ref # 39154B)	39154-1139	2
BOLT,SOCKET,6X20 (Ref # 92151)	92151-1750	4
BOLT,SOCKET,6X16 (Ref # 92151A)	92151-1751	4
BOLT,SOCKET,8X25 (Ref # 92151B)	92151-1753	2
BOLT,SOCKET,6X25 (Ref # 92151C)	92151-1945	6
BOLT,SOCKET,8X20 (Ref # 92153)	92153-0912	2
BOLT,SOCKET,8X10 (Ref # 92153A)	92153-1278	8
DAMPER,WINDSHIELD,CNT,OUTER (Ref # 92161)	92161-0268	1
DAMPER,WINDSHIELD,CNT,INNER (Ref # 92161A)	92161-0269	1
DAMPER,WINDSHIELD,OUTER,LH&RH (Ref # 92161B)	92161-0270	2
DAMPER,WINDSHIELD,INNER,LH&RH (Ref # 92161C)	92161-0271	2
WASHER,6.5X14.5X1.5 (Ref # 92200)	92200-3775	14
NUT,CAP,6MM (Ref # 92210)	92210-0220	10

2007 Vulcan 1600 Nomad PARTS LIST

Cowling

ITEM NAME	PART NUMBER	QUANTITY
NUT,CAP,6MM (Ref # 92210A)	92210-1129	4