

2019 TERYX® PARTS DIAGRAM

Oil Pump/Oil Filter

E1710

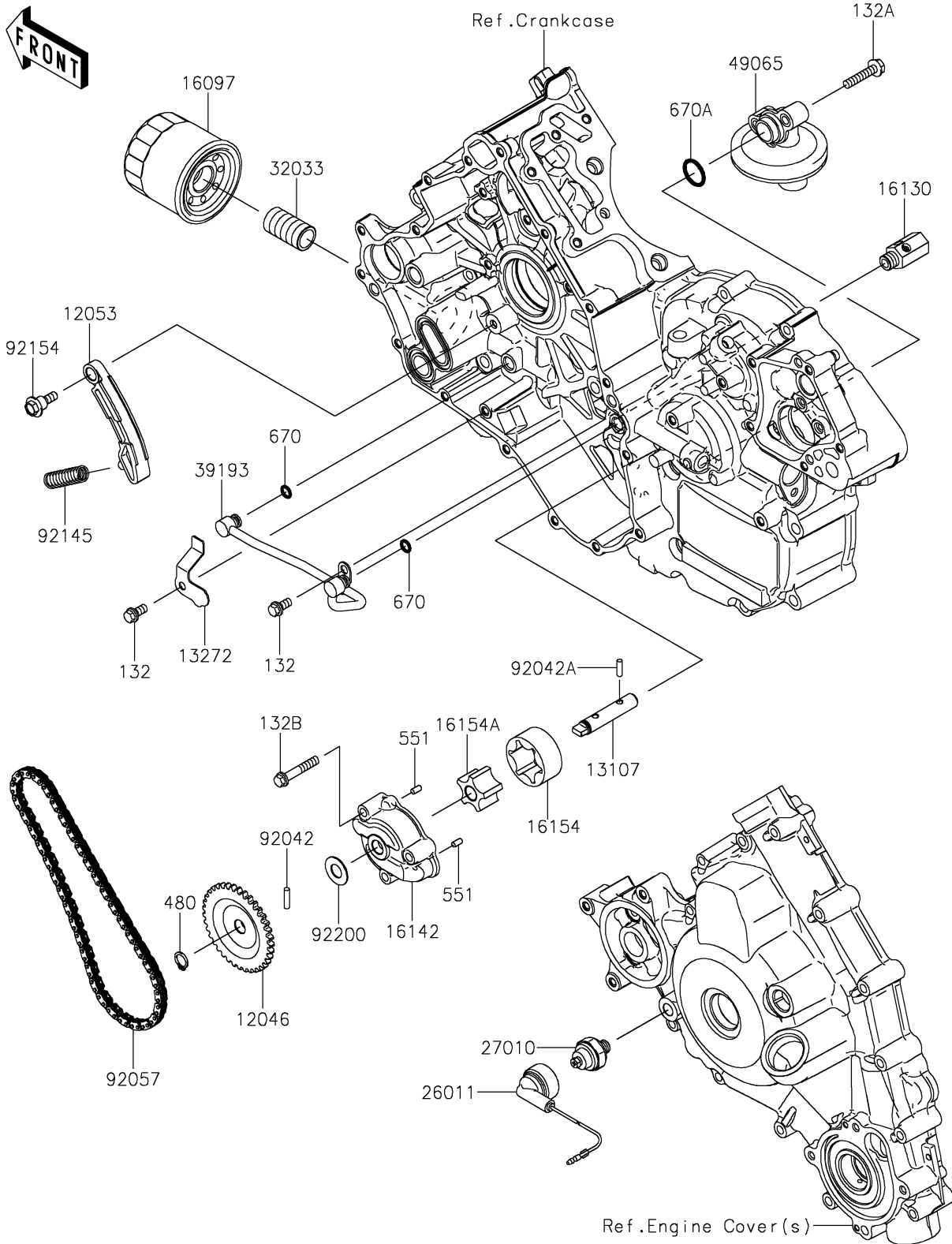

2019 TERYX® PARTS LIST

Oil Pump/Oil Filter

ITEM NAME	PART NUMBER	QUANTITY
SPROCKET,OIL PUMP,37T (Ref # 12046)	12046-0577	1
GUIDE-CHAIN (Ref # 12053)	12053-0180	1
SHAFT,OIL PUMP (Ref # 13107)	13107-0718	1
PLATE (Ref # 13272)	13272-0988	1
FILTER-ASSY-OIL (Ref # 16097)	16097-0007	1
VALVE-ASSY-RELIEF (Ref # 16130)	16130-1058	1
COVER-PUMP (Ref # 16142)	16142-0704	1
ROTOR-PUMP,OUTER (Ref # 16154)	16154-0706	1
ROTOR-PUMP,INNER (Ref # 16154A)	16154-0707	1
WIRE-LEAD (Ref # 26011)	26011-0818	1
SWITCH,OIL PRESSURE (Ref # 27010)	27010-1313	1
PIPE,OIL FILTER (Ref # 32033)	32033-1535	1
PIPE-OIL (Ref # 39193)	39193-0570	1
FILTER-OIL (Ref # 49065)	49065-0710	1
PIN,DOWEL,4X16.8 (Ref # 92042)	92042-029	1
PIN,DOWEL,4X13.8 (Ref # 92042A)	92042-030	1
CHAIN,DID SCR-0409 SV (Ref # 92057)	92057-0561	1
SPRING (Ref # 92145)	92145-0830	1
BOLT,FLANGED,6X8.3 (Ref # 92154)	92154-0709	1
WASHER,11.3X23X1 (Ref # 92200)	92200-0719	1
BOLT-FLANGED-SMALL,6X12 (Ref # 132)	132BA0612	2
BOLT-FLANGED-SMALL,6X30 (Ref # 132A)	132BA0630	2
BOLT-FLANGED-SMALL,6X35 (Ref # 132B)	132BA0635	3
CIRCLIP-TYPE-C,11MM (Ref # 480)	480J1100	1
PIN-DOWEL,4X8 (Ref # 551)	551A0408	2
O RING,7MM (Ref # 670)	670D1507	2
O RING,18MM (Ref # 670A)	670D2018	1