

1999 KX80 PARTS DIAGRAM

Brake Pedal

F2260

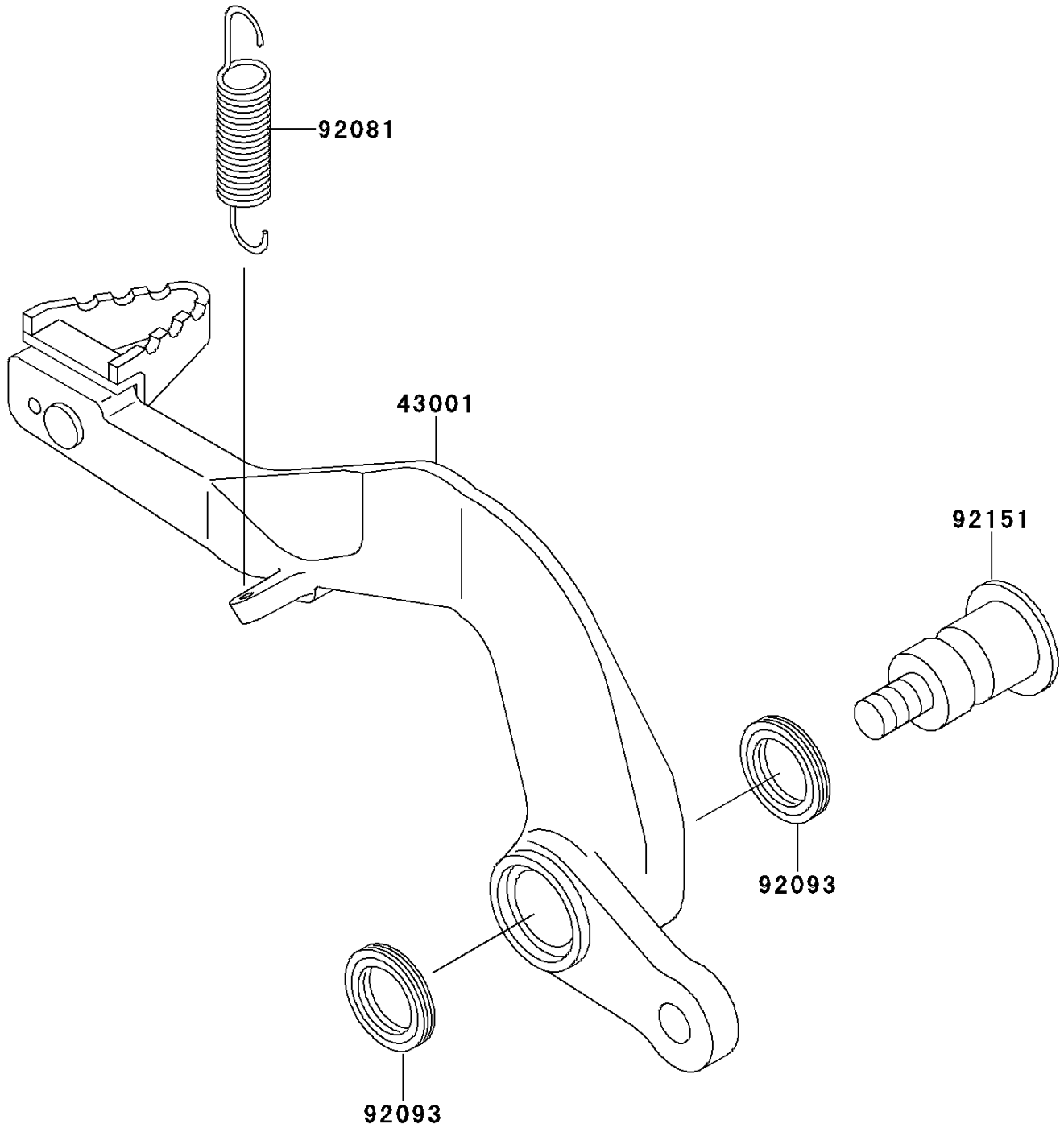

1999 KX80 PARTS LIST

Brake Pedal

| ITEM NAME | PART NUMBER | QUANTITY |
|---|-------------|----------|
| LEVER-BRAKE,PEDAL (Ref # 43001) | 43001-1389 | 1 |
| SPRING,BRAKE PEDAL RETURN (Ref # 92081) | 92081-1932 | 1 |
| SEAL,MY15.9X20X2.8 (Ref # 92093) | 92093-1433 | 2 |
| BOLT (Ref # 92151) | 92151-1104 | 1 |