

2020 TERYX4™ CAMO PARTS DIAGRAM

Frame

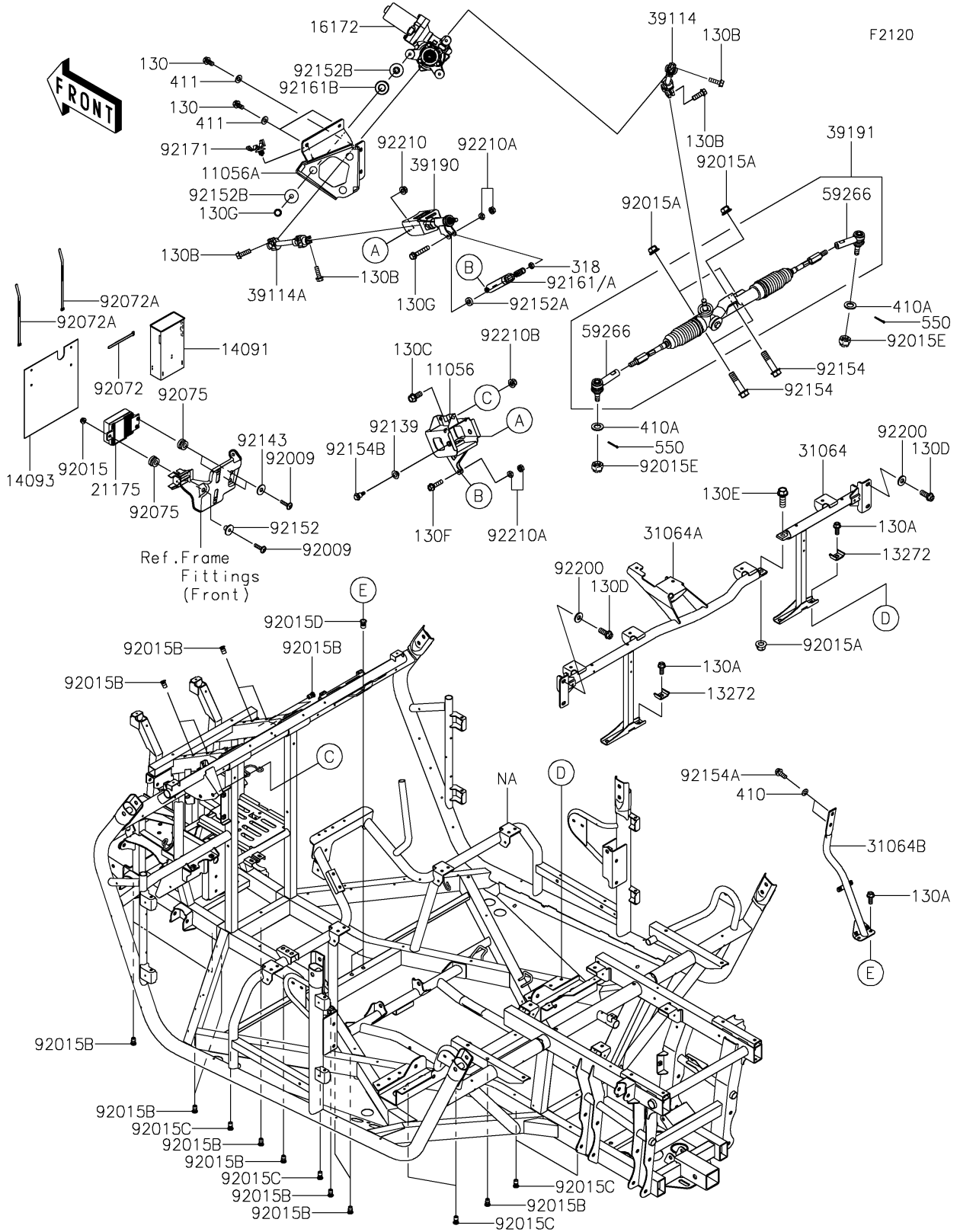

2020 TERYX4™ CAMO PARTS LIST

Frame

ITEM NAME	PART NUMBER	QUANTITY
BRACKET,HOLDER (Ref # 11056)	11056-7157	1
BRACKET (Ref # 11056A)	11056-7781	1
PLATE (Ref # 13272)	13272-1336	4
COVER,ECU (Ref # 14091)	14091-7560	1
COVER (Ref # 14093)	14093-0397	1
ACTUATOR,EPS (Ref # 16172)	16172-0557	1
CONTROL UNIT-ELECTRONIC (Ref # 21175)	21175-0809	1
PIPE-COMP,SUB FRAME,SEAT,RH (Ref # 31064)	31064-0658	1
PIPE-COMP,SUB FRAME,SEAT,LH (Ref # 31064A)	31064-0667	1
PIPE-COMP (Ref # 31064B)	31064-0676	1
SHAFT-COMP-STRG (Ref # 39114)	39114-0017	1
SHAFT-COMP-STRG (Ref # 39114A)	39114-0020	1
SHAFT-ASSY-STEERING (Ref # 39190)	39190-0006	1
GEAR-ASSY-STEERING (Ref # 39191)	39191-0018	1
JOINT-BALL (Ref # 59266)	59266-0706	2
SCREW,6X25 (Ref # 92009)	92009-1465	3
NUT,FLANGED,6MM (Ref # 92015)	92015-1367	1
NUT,LOCK,FLANGED,12MM (Ref # 92015A)	92015-1433	4
NUT,POP,6MM,L=15 (Ref # 92015B)	92015-1791	24
NUT,POP,6MM,L=16.5 (Ref # 92015C)	92015-1792	12
NUT,POP,8MM,L=16.5 (Ref # 92015D)	92015-1793	2
NUT,CASTLE,14MM (Ref # 92015E)	92015-1841	2
BAND,L=123 (Ref # 92072)	92072-030	1
BAND,L=188 (Ref # 92072A)	92072-1239	2
DAMPER,RUBBER (Ref # 92075)	92075-1123	3
BUSHING (Ref # 92139)	92139-0230	2
COLLAR,L=6.5 (Ref # 92143)	92143-1025	2
COLLAR,6.5X10X13.3 (Ref # 92152)	92152-0957	1
COLLAR,8.2X18X5 (Ref # 92152A)	92152-1848	1

2020 TERYX4™ CAMO PARTS LIST

Frame

ITEM NAME	PART NUMBER	QUANTITY
COLLAR,8.5X30X10.6 (Ref # 92152B)	92152-2149	6
BOLT,FLANGED,12X50 (Ref # 92154)	92154-1008	3
BOLT,FLANGED,8X20 (Ref # 92154A)	92154-1130	2
BOLT,6X21.5 (Ref # 92154B)	92154-1320	2
DAMPER,GAS SPRING (Ref # 92161A)	92161-1825	1
DAMPER,ACTUATOR (Ref # 92161B)	92161-7517	3
CLAMP (Ref # 92171)	92171-0453	1
WASHER,10.2X23X2.5 (Ref # 92200)	92200-0211	4
NUT,LOCK,FLANGED,6MM (Ref # 92210)	92210-0303	2
NUT,HARD LOCK,8MM (Ref # 92210A)	92210-0934	2
NUT,LOCK,FLANGED,10MM (Ref # 92210B)	92210-1080	1
BOLT-FLANGED,8X16 (Ref # 130)	130BA0816	4
BOLT-FLANGED,8X20 (Ref # 130A)	130BA0820	6
BOLT-FLANGED,8X25 (Ref # 130B)	130BA0825	4
BOLT-FLANGED,10X22 (Ref # 130C)	130BA1022	2
BOLT-FLANGED,10X25 (Ref # 130D)	130BA1025	4
BOLT-FLANGED,12X35 (Ref # 130E)	130BA1235	1
BOLT-FLANGED,8X30 (Ref # 130F)	130CA0830	1
BOLT-FLANGED,8X45 (Ref # 130G)	130CA0845	4
NUT-HEX-SMALL,8MM (Ref # 318)	318BA0800	1
WASHER-PLAIN-SMALL,8MM (Ref # 410)	410AA0800	2
WASHER-PLAIN-SMALL,14MM (Ref # 410A)	410AA1400	2
WASHER-PLAIN,8MM (Ref # 411)	411AA0800	4
PIN-COTTER,3.0X25 (Ref # 550)	550AA3025	2