

# 2004 KX85 PARTS DIAGRAM

Shock Absorber(s)

F2280

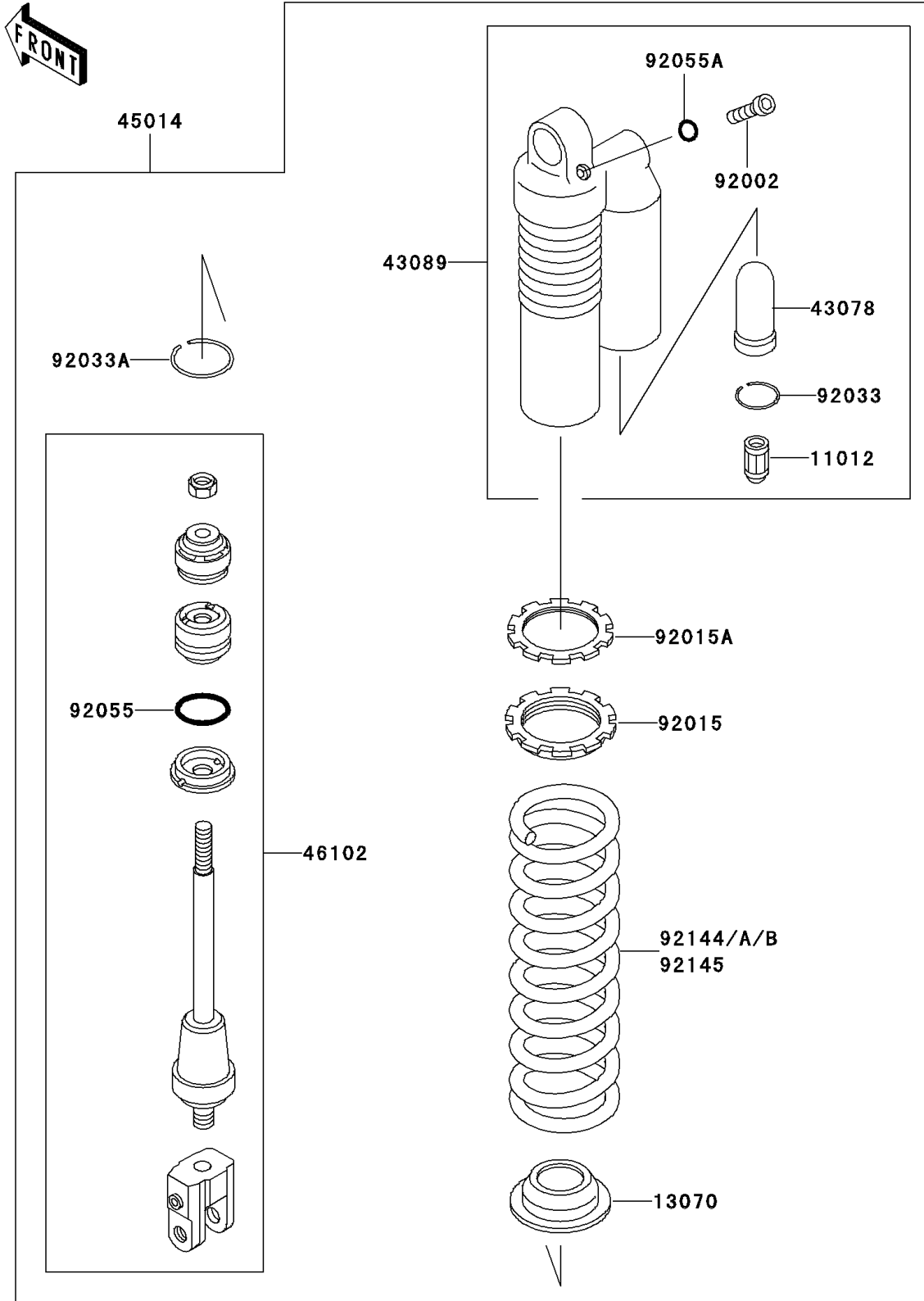

## 2004 KX85 PARTS LIST

### Shock Absorber(s)

ITEM NAME	PART NUMBER	QUANTITY
CAP,VALVE AIR (Ref # 11012)	11012-1391	1
GUIDE,SPRING (Ref # 13070)	13070-1233	1
RESERVOIR,SHOCKABSORBER (Ref # 43078)	43078-1112	1
CYLINDER-SHOCKABSORBER (Ref # 43089)	43089-1162	1
SHOCKABSORBER,I.SILVER (Ref # 45014)	45014-1662-8V	1
ROD,SHOCKABSORBER (Ref # 46102)	46102-1411	1
BOLT,DRAIN (Ref # 92002)	92002-1955	1
NUT,SPRING ADJUST (Ref # 92015)	92015-1679	1
NUT,SPRING ADJUST LOCK (Ref # 92015A)	92015-1713	1
RING-SNAP,REARSHOCK (Ref # 92033)	92033-1091	1
RING-SNAP,SHOCKABSORBER (Ref # 92033A)	92033-1211	1
RING-O,ROD (Ref # 92055)	92055-1334	1
RING-O (Ref # 92055A)	92055-1383	1
SPRING,SHOCKABSORBER,K=4.6,SIL (Ref # 92144)	92144-1570-8V	1
SPRING,SHOCKABSORBER,K=5.0,SIL (Ref # 92144A)	92144-1571-8V	1
SPRING,SHOCKABSORBER,K=4.8,SIL (Ref # 92144B)	92144-1945-8V	1
SPRING,SHOCKABSORBER,K=4.4,SIL (Ref # 92145)	92145-1371-8V	1