

2015 Ninja® ZX™ -10R PARTS DIAGRAM

Footrests

F2160

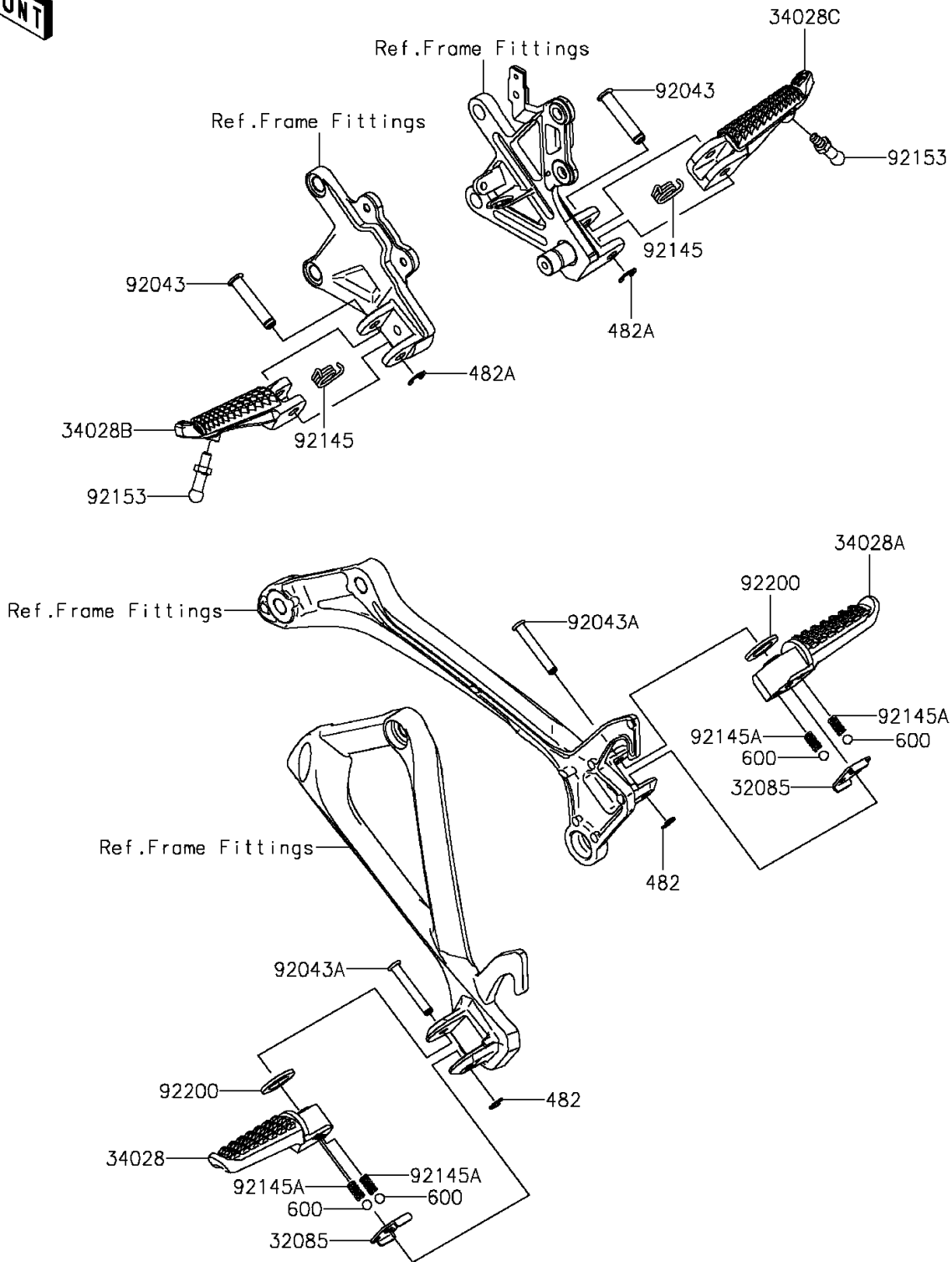

2015 Ninja® ZX™ -10R PARTS LIST

Footrests

ITEM NAME	PART NUMBER	QUANTITY
STOPPER,REAR STEP (Ref # 32085)	32085-0047	2
STEP,RR,LH (Ref # 34028)	34028-0094	1
STEP,RR,RH (Ref # 34028A)	34028-0095	1
STEP,FR,LH (Ref # 34028B)	34028-0139	1
STEP,FR,RH (Ref # 34028C)	34028-0140	1
PIN,8X40.5 (Ref # 92043)	92043-1326	2
PIN,6X40 (Ref # 92043A)	92043-1595	2
SPRING (Ref # 92145)	92145-0780	2
SPRING (Ref # 92145A)	92145-1319	4
BOLT,BANK SENSOR (Ref # 92153)	92153-1946	2
WASHER,16X26X2.3 (Ref # 92200)	92200-0043	2
CIRCLIP-TYPE-E (Ref # 482)	482EA5000	2
CIRCLIP-TYPE-E (Ref # 482A)	482EA7000	2
BALL-STEEL,1/4 (Ref # 600)	600A0800	4