

2004 KX85 PARTS DIAGRAM

Fuel Tank

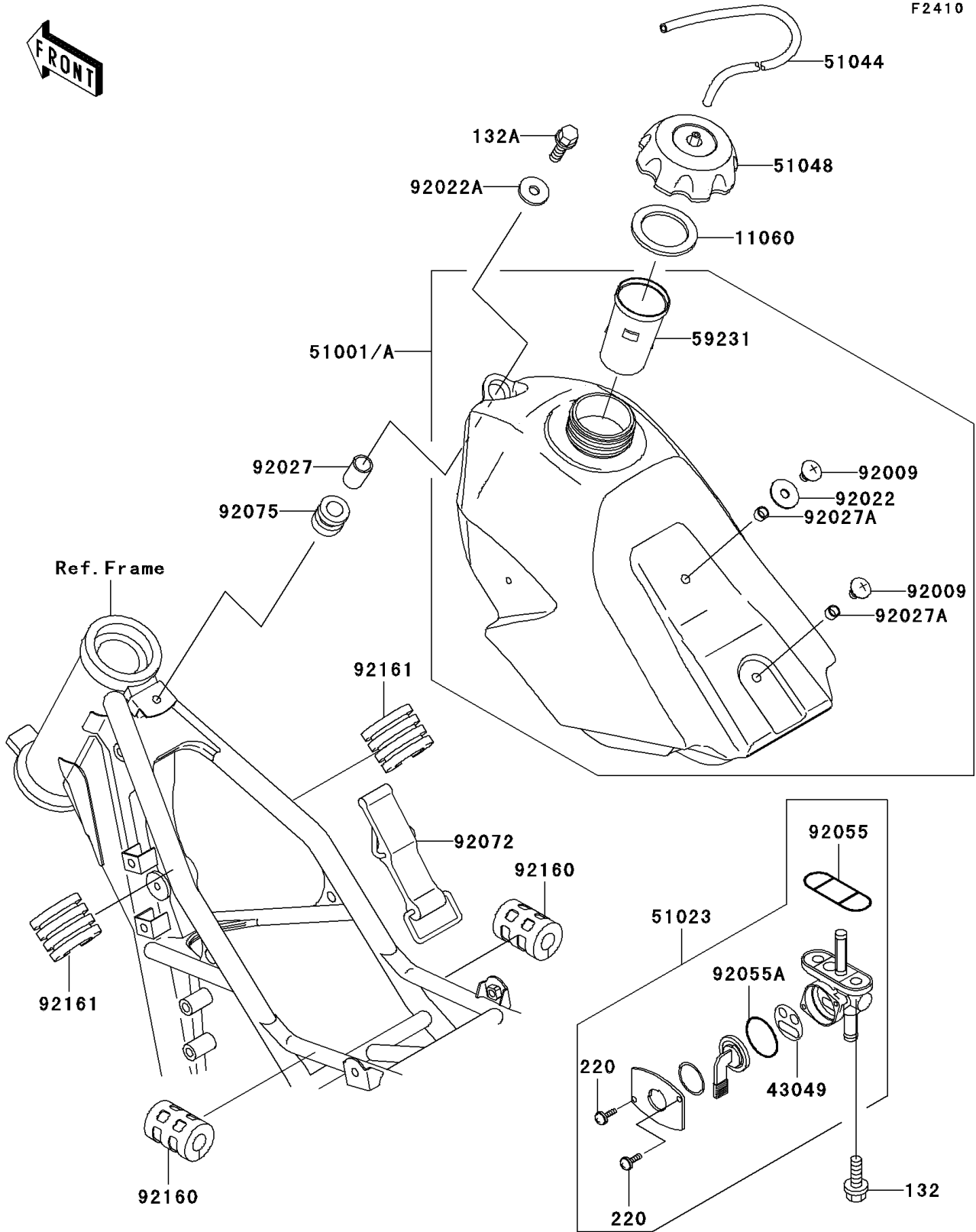

2004 KX85 PARTS LIST

Fuel Tank

| ITEM NAME | PART NUMBER | QUANTITY |
|---------------------------------------|---------------|----------|
| BOLT-FLANGED-SMALL (Ref # 132) | 132G0612 | 2 |
| BOLT-FLANGED-SMALL (Ref # 132A) | 132G0625 | 1 |
| SCREW-PAN-CROS (Ref # 220) | 220B0308 | 2 |
| GASKET,FUEL TANK CAP (Ref # 11060) | 11060-1340 | 1 |
| PACKING,TAP VALVE (Ref # 43049) | 43049-1091 | 1 |
| TANK-COMP-FUEL,F.BLACK (Ref # 51001A) | 51001-1677-6Z | 1 |
| TAP-ASSY,FUEL (Ref # 51023) | 51023-1339 | 1 |
| TUBE-ASSY (Ref # 51044) | 51044-1185 | 1 |
| CAP-ASSY-TANK,FUEL (Ref # 51048) | 51048-1124 | 1 |
| FILLER (Ref # 59231) | 59231-1096 | 1 |
| SCREW,6X10 (Ref # 92009) | 92009-1530 | 2 |
| WASHER,PLAIN,6MM (Ref # 92022) | 92022-165 | 1 |
| WASHER,6.5X24X2 (Ref # 92022A) | 92022-1690 | 1 |
| COLLAR,6.8X10X14 (Ref # 92027) | 92027-1966 | 1 |
| COLLAR,6.2X7.8X5 (Ref # 92027A) | 92027-2096 | 2 |
| RING-O,FUEL TAP PACKING (Ref # 92055) | 92055-1348 | 1 |
| RING-O,TAP LEVER (Ref # 92055A) | 92055-1419 | 1 |
| BAND,FUEL TANK (Ref # 92072) | 92072-1229 | 1 |
| DAMPER (Ref # 92075) | 92075-1787 | 1 |
| DAMPER,FUEL TANK (Ref # 92160) | 92160-1236 | 2 |
| DAMPER,FUEL TANK (Ref # 92161) | 92161-1175 | 2 |