

1994 Police 1000 PARTS DIAGRAM

Camshaft(s)/Tensioner

E1230-0019

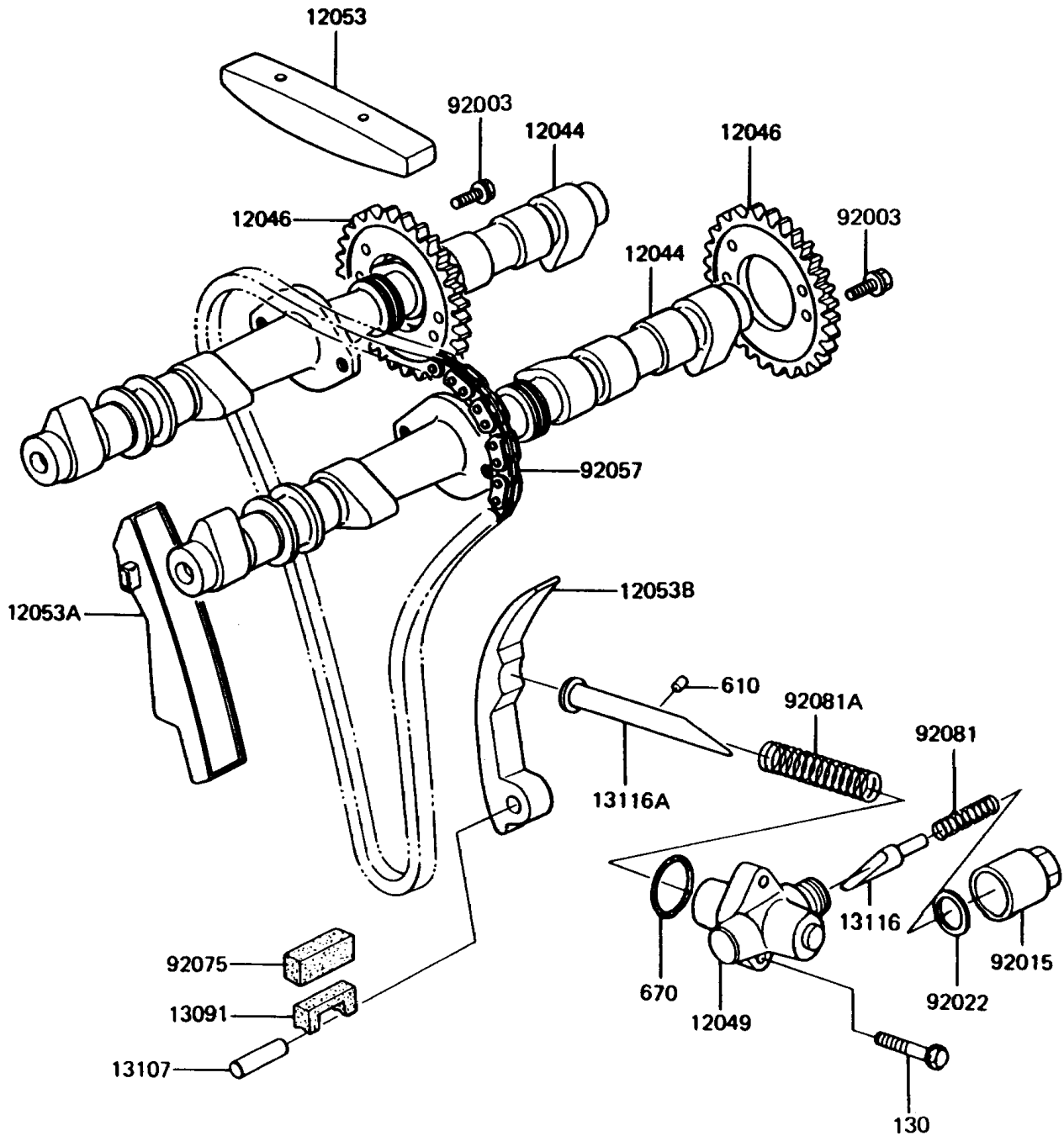

1994 Police 1000 PARTS LIST

Camshaft(s)/Tensioner

ITEM NAME	PART NUMBER	QUANTITY
CAMSHAFT-VALVE (Ref # 12044)	12044-1027	2
SPROCKET,CAMSHAFT,42T (Ref # 12046)	12046-1025	2
TENSIONER,CAM CHAIN (Ref # 12049)	12049-1009	1
GUIDE-CHAIN,CAM,HEAD (Ref # 12053)	12053-1018	1
GUIDE-CHAIN,CAM,FR (Ref # 12053A)	12053-1048	1
GUIDE-CHAIN,CAM,RR (Ref # 12053B)	12053-1049	1
HOLDER,CAM CHAIN GUIDE (Ref # 13091)	13091-1084	1
SHAFT,8X28 (Ref # 13107)	13107-1020	1
ROD-PUSH,TENSIONER (Ref # 13116)	13116-1012	1
ROD-PUSH,TENSIONER (Ref # 13116A)	13116-1038	1
BOLT,FLANGED,6X11 (Ref # 92003)	92003-208	4
NUT,CAP,18MM (Ref # 92015)	92015-1100	1
WASHER,18.3X24X1.4 (Ref # 92022)	92022-1175	1
CHAIN,CAMSHAFT,75-010X152L (Ref # 92057)	92057-1052	1
DAMPER,CAM CHAIN GUIDE (Ref # 92075)	92075-1270	1
SPRING,TENSIONER (Ref # 92081)	92081-1302	1
SPRING,TENSIONER (Ref # 92081A)	92081-1380	1
BOLT-FLANGED (Ref # 130)	130Y0625	2
ROLLER,4X8 (Ref # 610)	610A0408	1
O RING,22MM (Ref # 670)	670D2022	1