

1993 Police 1000 PARTS DIAGRAM

Clutch

E1350-0047

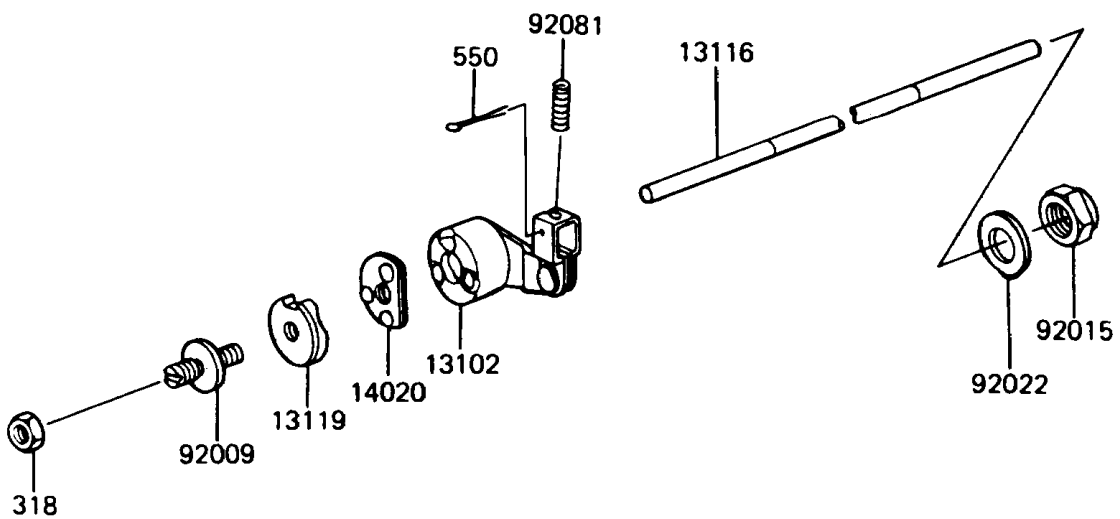
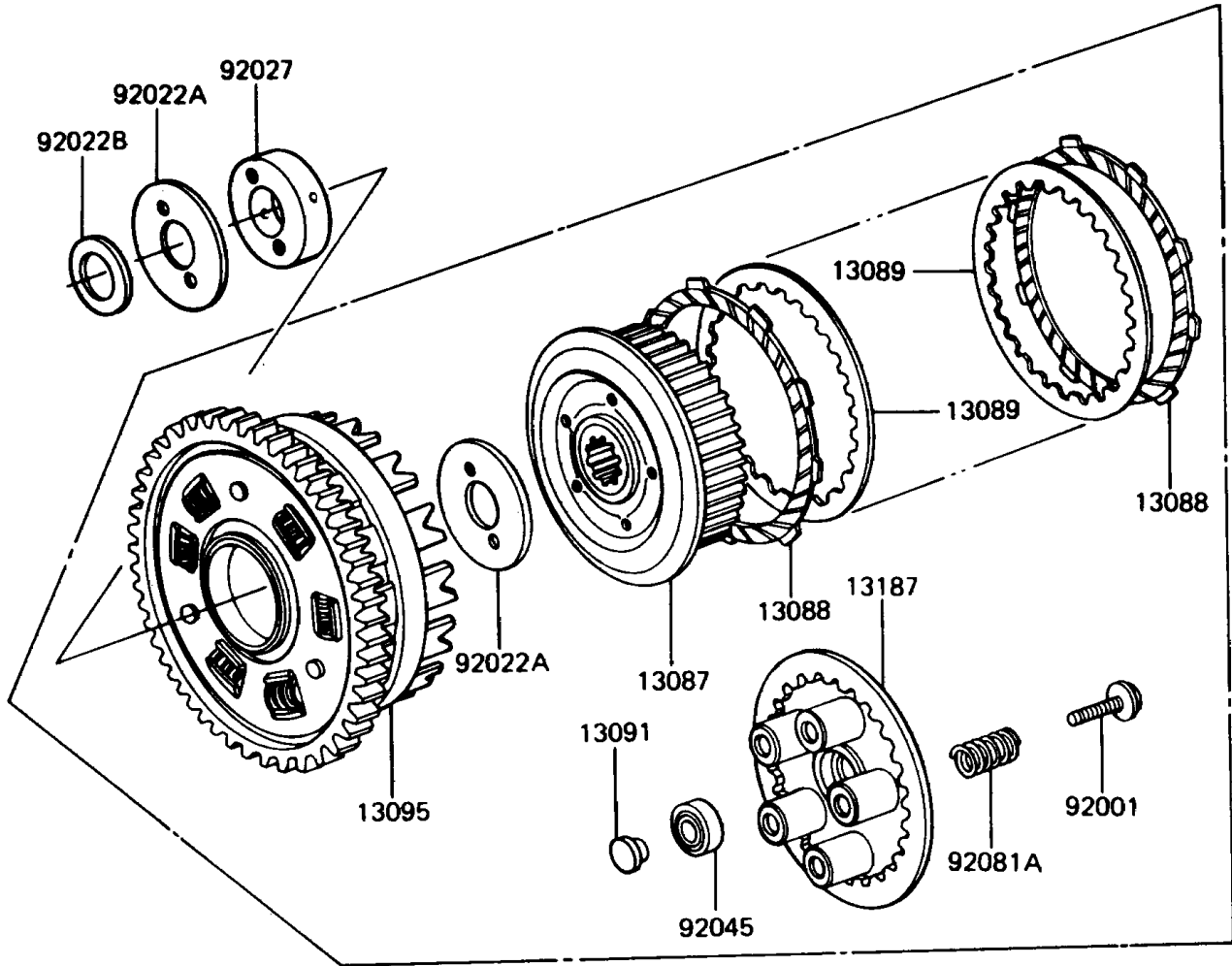

1993 Police 1000 PARTS LIST

Clutch

ITEM NAME	PART NUMBER	QUANTITY
HUB-CLUTCH (Ref # 13087)	13087-1015	1
PLATE-FRICTION (Ref # 13088)	13088-1013	9
PLATE-CLUTCH,T=2.3 (Ref # 13089)	13089-1004	8
HOLDER,CLUTCH PUSH ROD (Ref # 13091)	13091-1085	1
HOUSING-COMP-CLUTCH (Ref # 13095)	13095-1037	1
RELEASE-COMP-CLUTCH (Ref # 13102)	13102-1012	1
ROD-PUSH,CLUTCH (Ref # 13116)	13116-1148	1
CAM-RELEASE,CLUTCH (Ref # 13119)	13119-1003	1
PLATE-CLUTCH OPERATING (Ref # 13187)	13187-1006	1
RETAINER,CLUTCH RELEASE (Ref # 14020)	14020-1091	1
BOLT,FLANGED,6X18 (Ref # 92001)	92001-1066	5
SCREW,8MM (Ref # 92009)	92009-1009	1
NUT,20MM (Ref # 92015)	92015-1555	1
WASHER,20.3X36X2.3 (Ref # 92022)	92022-1116	1
WASHER,CLUTCH THRUST (Ref # 92022A)	92022-1221	2
WASHER,25.3X36X2.5 (Ref # 92022B)	92022-1223	1
COLLAR,25X57X16.1 (Ref # 92027)	92027-1284	1
BEARING-BALL,6001C3ML01 (Ref # 92045)	92045-1235	1
SPRING,CLUTCH RELEASE (Ref # 92081)	92081-069	1
SPRING,CLUTCH (Ref # 92081A)	92081-1033	5
NUT-HEX-SMALL,8MM (Ref # 318)	318B0800	1
PIN-COTTER,1.6X15 (Ref # 550)	550D1615	1