

2021 VULCAN® S PARTS DIAGRAM

Clutch

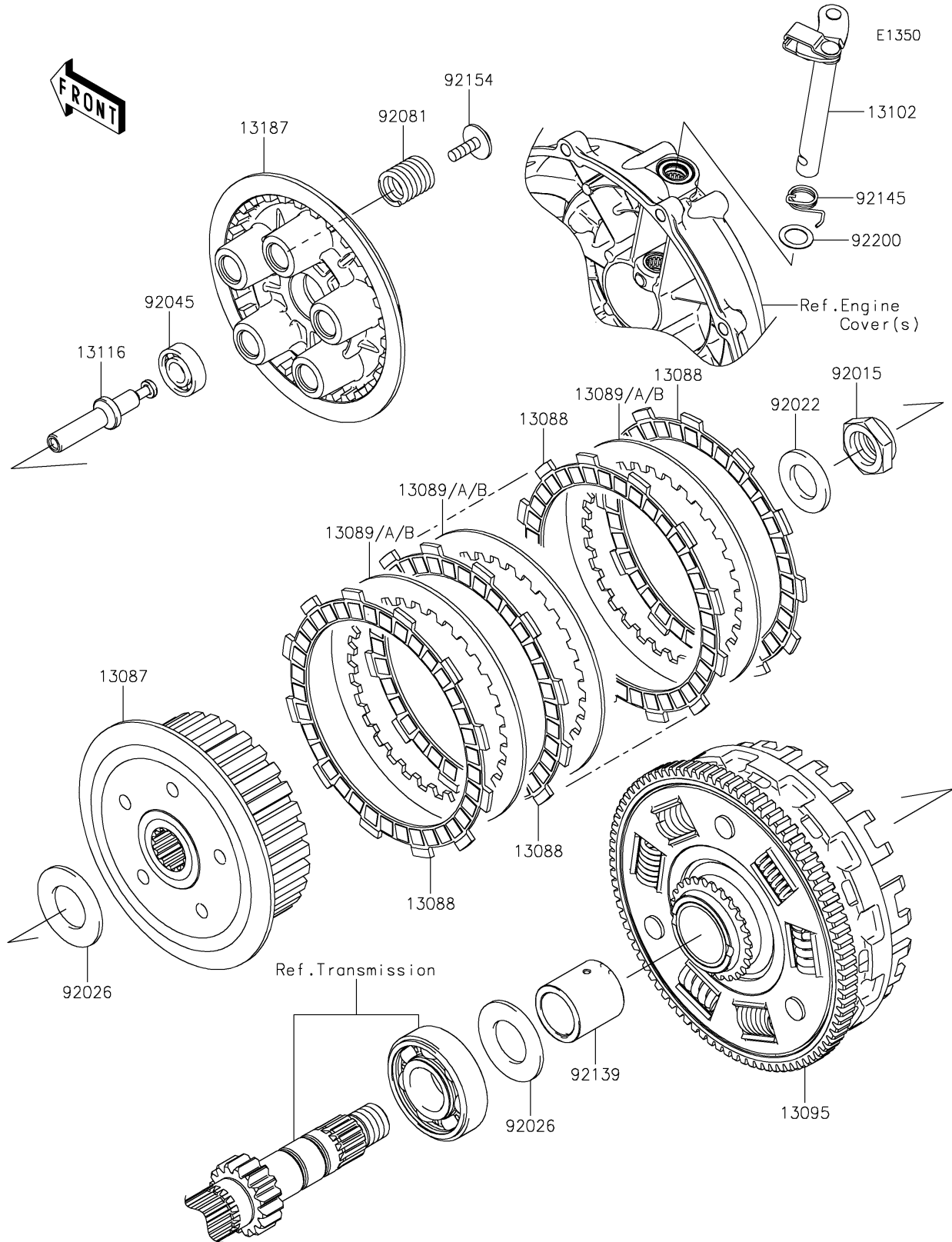

2021 VULCAN® S PARTS LIST

Clutch

ITEM NAME	PART NUMBER	QUANTITY
-----------	-------------	----------