

2021 VULCAN® S PARTS DIAGRAM

Meter(s)

F2530

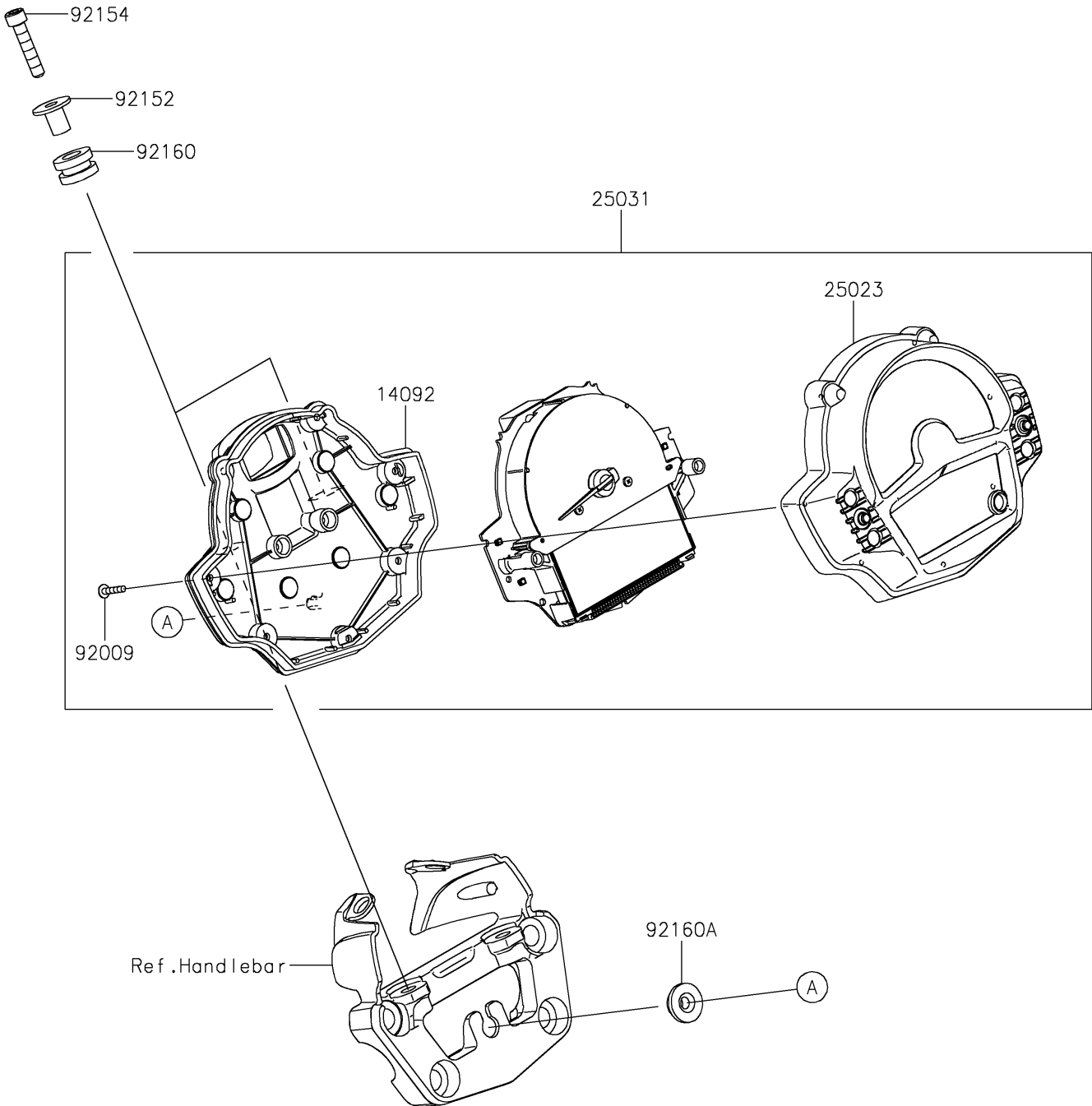

2021 VULCAN® S PARTS LIST

Meter(s)

ITEM NAME	PART NUMBER	QUANTITY
COVER,METER (Ref # 14092)	14092-0865	1
COVER-METER CASE (Ref # 25023)	25023-0102	1
METER-ASSY,COMBINATION (Ref # 25031)	25031-0721	1
SCREW,TAPPING,3X16 (Ref # 92009)	92009-1391	9
COLLAR,6.3X9.5X13.5 (Ref # 92152)	92152-1942	2
BOLT,SOCKET,6X30 (Ref # 92154)	92154-0962	2
DAMPER,10X20X12 (Ref # 92160)	92160-1167	2
DAMPER (Ref # 92160A)	92160-1613	1