

2022 VULCAN® S PARTS DIAGRAM

Ignition Switch/Locks/Reflectors

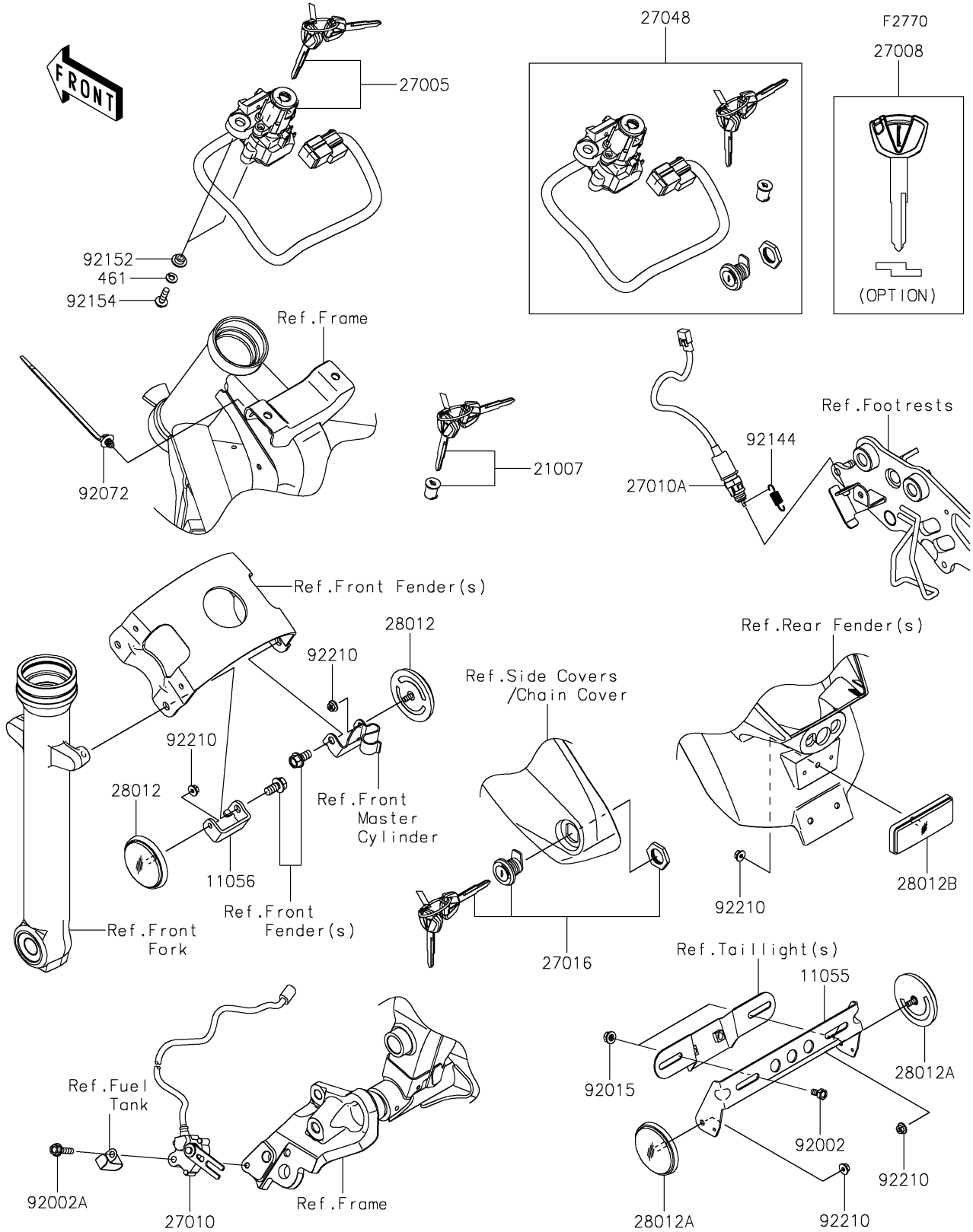

2022 VULCAN® S PARTS LIST

Ignition Switch/Locks/Reflectors

ITEM NAME	PART NUMBER	QUANTITY
BRACKET,REFLECTOR (Ref # 11055)	11055-1092	1
BRACKET,REFLECTOR,LH (Ref # 11056)	11056-7698	1
ROTOR,LOCK,TANK CAP (Ref # 21007)	21007-5077	1
SWITCH-ASSY-IGNITION (Ref # 27005)	27005-0595	1
KEY-LOCK,BLANK (Ref # 27008)	27008-0596	1
SWITCH,SIDE STAND (Ref # 27010)	27010-0722	1
SWITCH,RR BRAKE (Ref # 27010A)	27010-0760	1
LOCK-ASSY (Ref # 27016)	27016-5387	1
SWITCH-ASSY (Ref # 27048)	27048-5053	1
REFLECTOR-REFLEX,FR,SIDE (Ref # 28012)	28012-0001	2
REFLECTOR-REFLEX (Ref # 28012A)	28012-0002	2
REFLECTOR-REFLEX (Ref # 28012B)	28012-1077	1
BOLT,6X12 (Ref # 92002)	92002-1132	2
BOLT,FLANGED,6X25 (Ref # 92002A)	92002-1582	1
NUT,FLANGED,6MM (Ref # 92015)	92015-1367	2
BAND,OS170-FT7(BLACK) (Ref # 92072)	92072-1414	1
SPRING,REAR BRAKE SWITCH (Ref # 92144)	92144-1141	1
COLLAR,6.15X10.15X6 (Ref # 92152)	92152-1535	2
BOLT,FLANGED,6X20 (Ref # 92154)	92154-0107	2
NUT,FLANGED,5MM (Ref # 92210)	92210-0007	5
WASHER-SPRING,6MM (Ref # 461)	461DA0600	2