

1998 Police 1000 PARTS DIAGRAM

Transmission

E1361

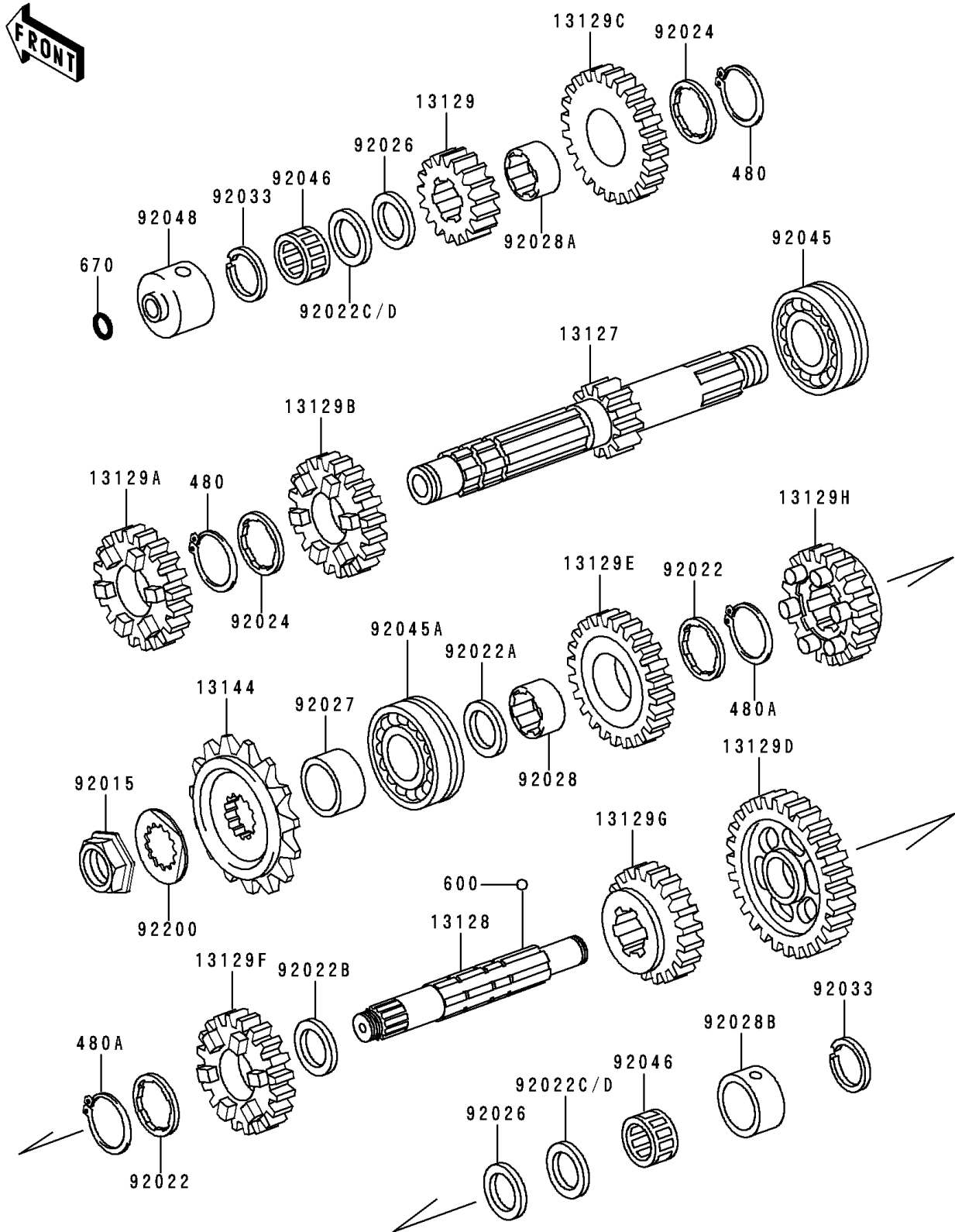

1998 Police 1000 PARTS LIST

Transmission

ITEM NAME	PART NUMBER	QUANTITY
CIRCLIP-TYPE-C,28MM (Ref # 480)	480J2800	2
CIRCLIP-TYPE-C,32MM (Ref # 480A)	480J3200	2
BALL-STEEL,3/16" (Ref # 600)	600A0600	3
O RING,8MM (Ref # 670)	670B1508	1
SHAFT-TRANSMISSION INPUT,14T (Ref # 13127)	13127-1034	1
SHAFT-TRANSMISSION OUTPUT (Ref # 13128)	13128-1048	1
GEAR,INPUT 2ND,18T (Ref # 13129)	13129-1235	1
GEAR,INPUT 3RD,21T (Ref # 13129A)	13129-1236	1
GEAR,INPUT 4TH,23T (Ref # 13129B)	13129-1237	1
GEAR,INPUT TOP,25T (Ref # 13129C)	13129-1238	1
GEAR,OUTPUT LOW,37T (Ref # 13129D)	13129-1239	1
GEAR,OUTPUT 2ND,33T (Ref # 13129E)	13129-1240	1
GEAR,OUTPUT 3RD,30T (Ref # 13129F)	13129-1241	1
GEAR,OUTPUT 4TH,27T (Ref # 13129G)	13129-1242	1
GEAR,OUTPUT TOP,26T (Ref # 13129H)	13129-1243	1
SPROCKET-OUTPUT,15T (Ref # 13144)	13144-1042	1
NUT,20MM (Ref # 92015)	92015-1210	1
WASHER,TOOTHED,30X42X1.4 (Ref # 92022)	92022-1218	2
WASHER,28.3X42X2.9 (Ref # 92022A)	92022-1219	1
WASHER,32.3X42X3 (Ref # 92022B)	92022-1220	1
WASHER,22.3X35X1.6 (Ref # 92022C)	92022-212	2
WASHER,22.3X35X1.2 (Ref # 92022D)	92022-213	AR
WASHER,TOOTHED,26X35.5X1.5 (Ref # 92024)	92024-042	2
SPACER,22X35.5X1.0 (Ref # 92026)	92026-1020	2
COLLAR,28X40X20.5 (Ref # 92027)	92027-1339	1
BUSHING,2ND GEAR (Ref # 92028)	92028-1112	1
BUSHING,TOP GEAR (Ref # 92028A)	92028-1124	1
BUSHING,OUTPUT SHAFT (Ref # 92028B)	92028-123	1
RING-SNAP,20X25.5X1.2 (Ref # 92033)	92033-025	2

1998 Police 1000 PARTS LIST

Transmission

ITEM NAME	PART NUMBER	QUANTITY
BEARING-BALL,5305NSH2 (Ref # 92045)	92045-1028	1
BEARING-BALL (Ref # 92045A)	92045-1186	1
BEARING-NEEDLE,FWF-223014 (Ref # 92046)	92046-031	2
RACE,DRIVE SHAFT BEARING (Ref # 92048)	92048-1012	1
WASHER,TOOTHED,23.9X45X1.0 (Ref # 92200)	92200-1234	1