

# 1998 Police 1000 PARTS DIAGRAM

Front Fork

F2340

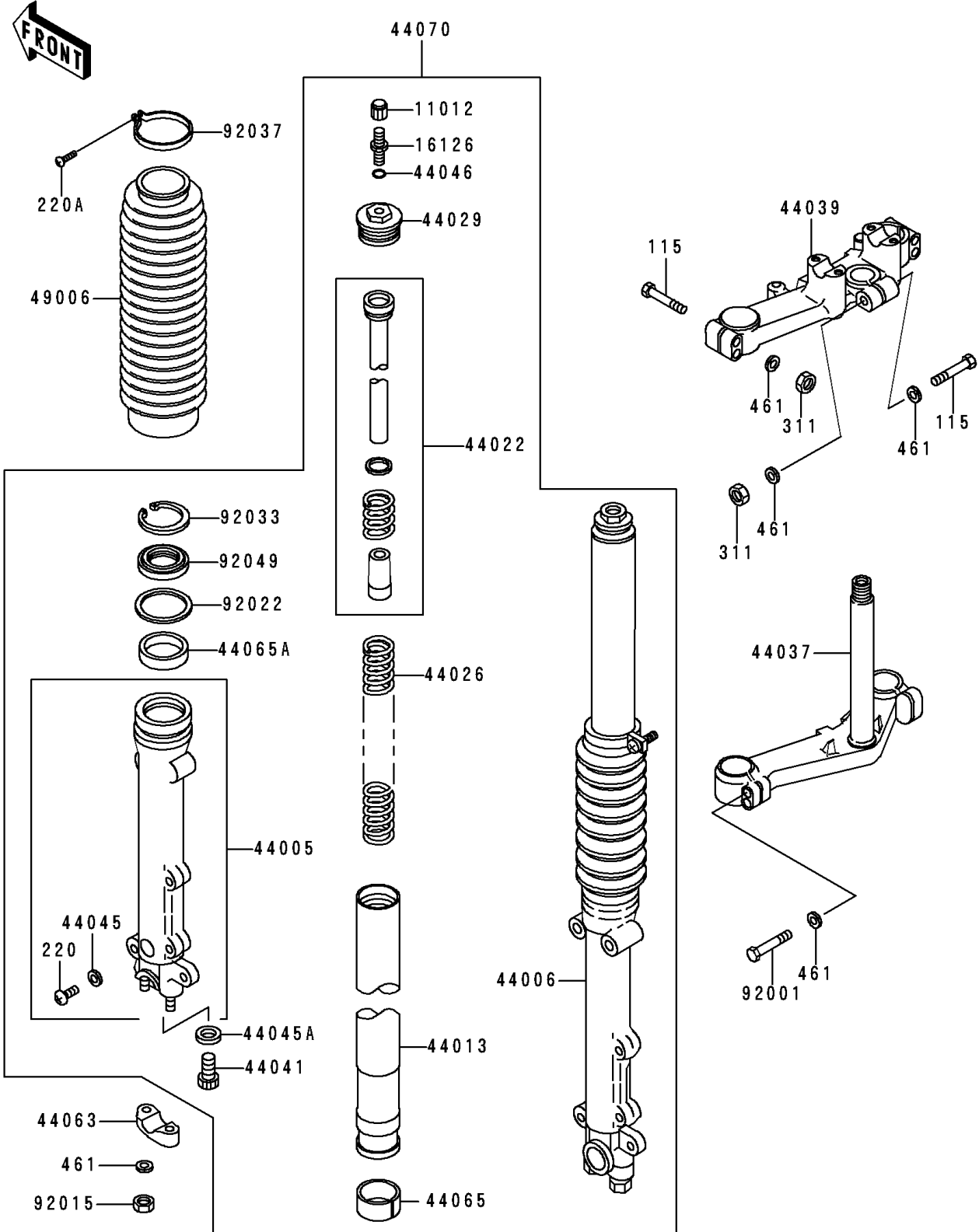

# 1998 Police 1000 PARTS LIST

## Front Fork

ITEM NAME	PART NUMBER	QUANTITY
BOLT-SMALL-UPSET (Ref # 115)	115G0855	5
SCREW-PAN-CROS,4X6 (Ref # 220)	220B0406	2
SCREW-PAN-CROS (Ref # 220A)	220B0420	2
NUT-HEX,8MM (Ref # 311)	311G0800	5
WASHER-SPRING,8MM (Ref # 461)	461F0800	13
CAP,AIR VALVE (Ref # 11012)	11012-1241	2
VALVE,AIR (Ref # 16126)	16126-1046	2
PIPE-LEFT FORK OUTER (Ref # 44005)	44005-1332	1
PIPE-RIGHT FORK OUTER (Ref # 44006)	44006-1328	1
PIPE-FORK INNER (Ref # 44013)	44013-4002	2
CYLINDER-FORK (Ref # 44022)	44022-1083	2
SPRING-FRONT FORK (Ref # 44026)	44026-1312	2
SEAT-FORK SPRING (Ref # 44029)	44029-4001	2
HOLDER-FORK UNDER (Ref # 44037)	44037-4004	1
HOLDER-FORK UPPER (Ref # 44039)	44039-4007	1
BOLT,SOCKET,FORK CYLINDER (Ref # 44041)	44041-040	2
GASKET,FORK DRAIN PLUG (Ref # 44045)	44045-002	2
GASKET (Ref # 44045A)	44045-057	2
RING-O (Ref # 44046)	44046-017	2
HOLDER-FRONT AXLE (Ref # 44063)	44063-011	2
BUSHING-FRONT FORK,INNER PIPE (Ref # 44065)	44065-1057	2
BUSHING-FRONT FORK,OUTER TUBE (Ref # 44065A)	44065-1091	2
DAMPER-ASSY,FORK (Ref # 44070)	44070-5139	1
BOOT,FORK,BLACK (Ref # 49006)	49006-1079	2
BOLT,8X38 (Ref # 92001)	92001-1700	4
NUT,LOCK,8MM (Ref # 92015)	92015-1390	4
WASHER,FORK OUTER PIPE (Ref # 92022)	92022-1262	2
RING-SNAP,FORK (Ref # 92033)	92033-1047	2
CLAMP,FORK BOOTS (Ref # 92037)	92037-1024	2

# 1998 Police 1000 PARTS LIST

Front Fork

ITEM NAME	PART NUMBER	QUANTITY
SEAL-OIL,FORK (Ref # 92049)	92049-1178	2