

1999 Police 1000 PARTS DIAGRAM

Seat

F2510

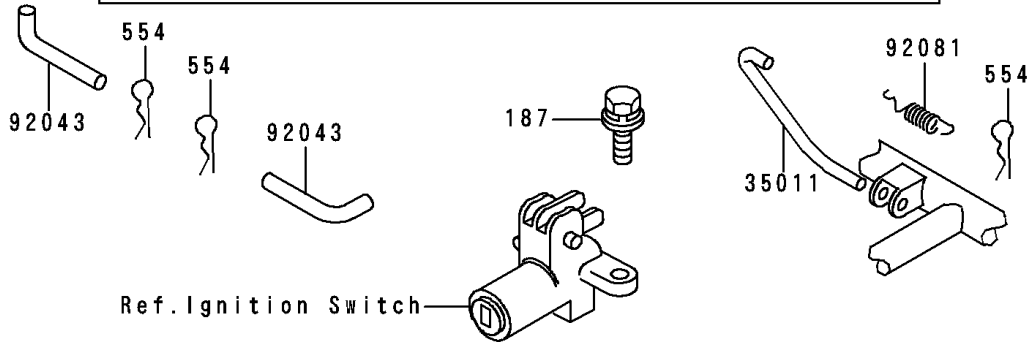
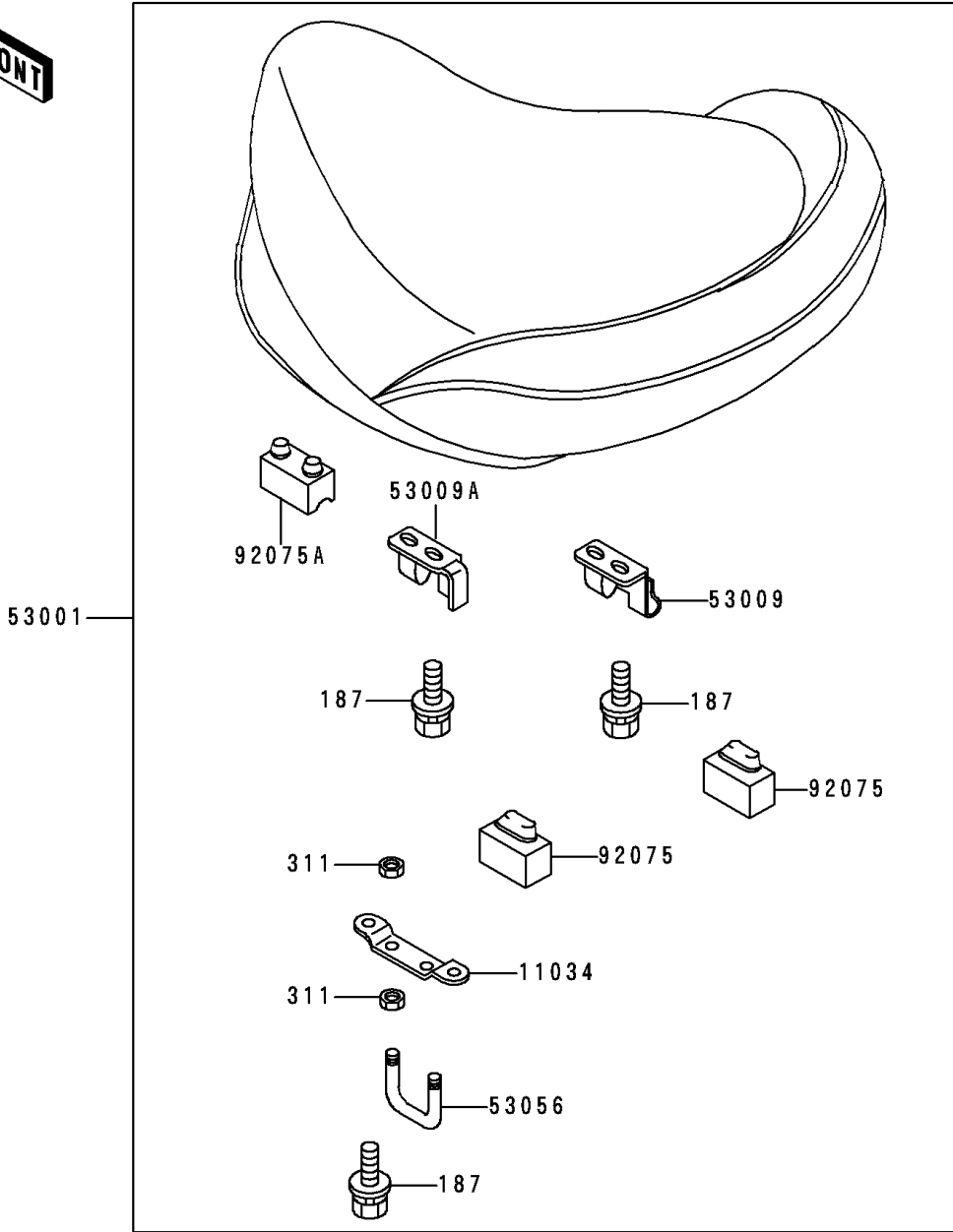

1999 Police 1000 PARTS LIST

Seat

ITEM NAME	PART NUMBER	QUANTITY
BOLT-UPSET-WSP (Ref # 187)	187B0614	7
NUT-HEX,6MM (Ref # 311)	311B0600	4
PIN-SNAP (Ref # 554)	554A0600	3
BRACKET,SEAT CATCH (Ref # 11034)	11034-1329	1
STAY,SEAT STAND (Ref # 35011)	35011-4003	1
SEAT-ASSY (Ref # 53001)	53001-1220	1
HINGE,SEAT (Ref # 53009)	53009-017	1
HINGE,SEAT,FR (Ref # 53009A)	53009-1029	1
HOOK,SEAT (Ref # 53056)	53056-002	1
PIN,SEAT PIVOT (Ref # 92043)	92043-1021	2
DAMPER (Ref # 92075)	92075-099	2
DAMPER,SEAT (Ref # 92075A)	92075-1133	1
SPRING,SEAT HOOK (Ref # 92081)	92081-1053	1