

2017 MULE SX™ PARTS DIAGRAM

Converter Cover

E1393

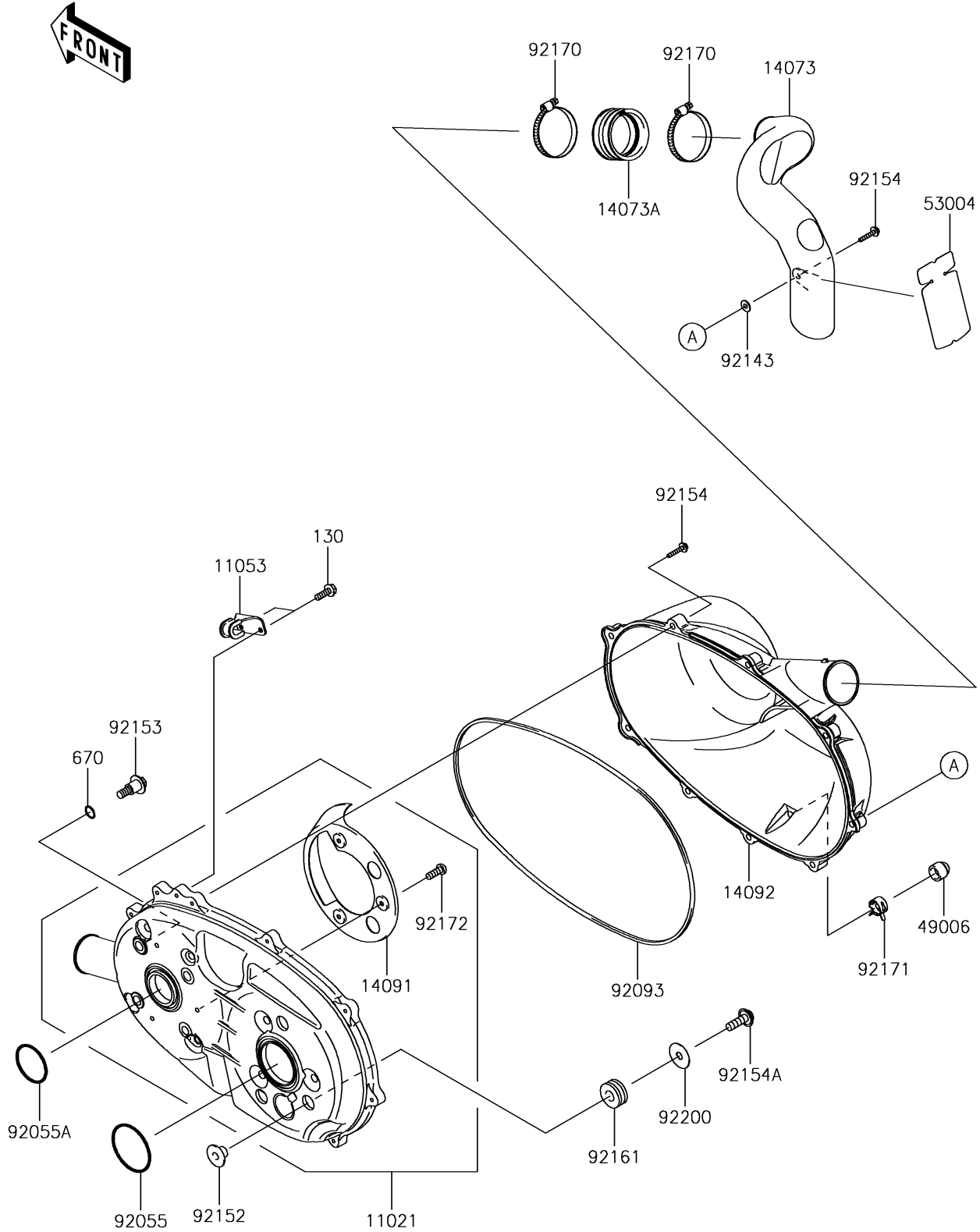

2017 MULE SX™ PARTS LIST

Converter Cover

ITEM NAME	PART NUMBER	QUANTITY
CASE-ASSY,BELT CONVERTER (Ref # 11021)	11021-0023	1
BRACKET (Ref # 11053)	11053-1483	1
DUCT,EXHAUST (Ref # 14073)	14073-0287	1
DUCT,JOINT (Ref # 14073A)	14073-1775	1
COVER (Ref # 14091)	14091-0391	1
COVER,BELT CONVERTER (Ref # 14092)	14092-1007	1
BOOT,DRAIN (Ref # 49006)	49006-3718	1
MAT (Ref # 53004)	53004-0051	1
RING-O,64MM (Ref # 92055)	92055-0748	1
RING-O,49.4MM (Ref # 92055A)	92055-0749	1
SEAL (Ref # 92093)	92093-0586	1
COLLAR (Ref # 92143)	92143-1087	1
COLLAR (Ref # 92152)	92152-0894	3
BOLT,8X26.5 (Ref # 92153)	92153-0594	4
BOLT,6X35 (Ref # 92154)	92154-0342	9
BOLT,FLANGED,8X25 (Ref # 92154A)	92154-1068	3
DAMPER (Ref # 92161)	92161-1484	3
CLAMP (Ref # 92170)	92170-1764	2
CLAMP (Ref # 92171)	92171-0329	1
SCREW,5X14 (Ref # 92172)	92172-0166	3
WASHER,8.5X29X0.8 (Ref # 92200)	92200-0574	3
BOLT-FLANGED,6X18 (Ref # 130)	130BA0618	2
O RING,12MM (Ref # 670)	670D2012	4