

2005 Police 1000 PARTS DIAGRAM

Crankcase Bolt Pattern

E1412

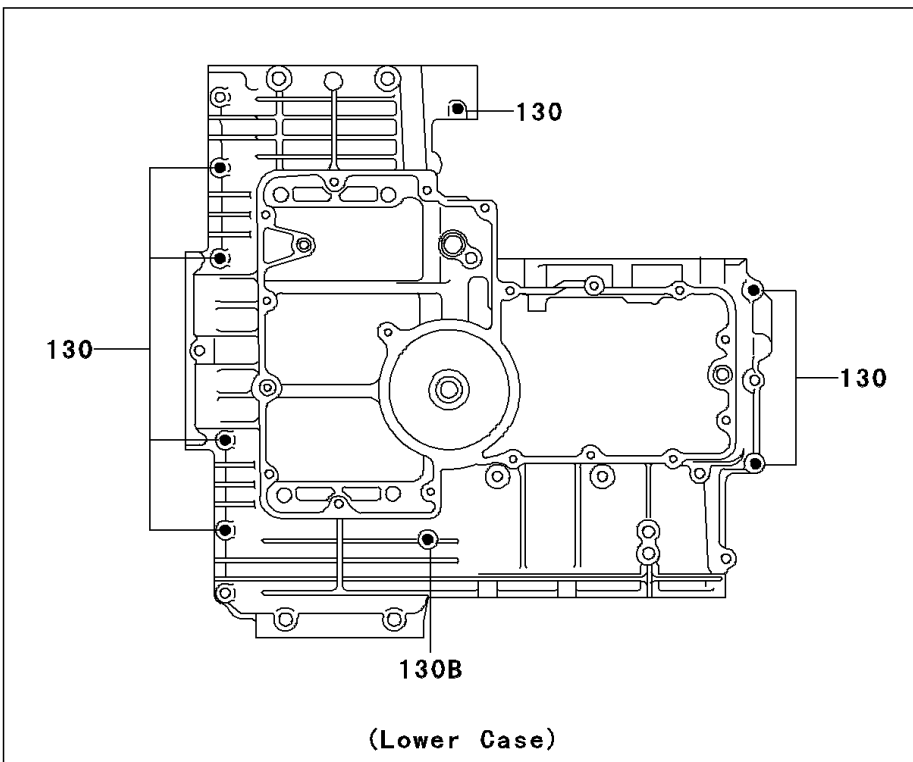
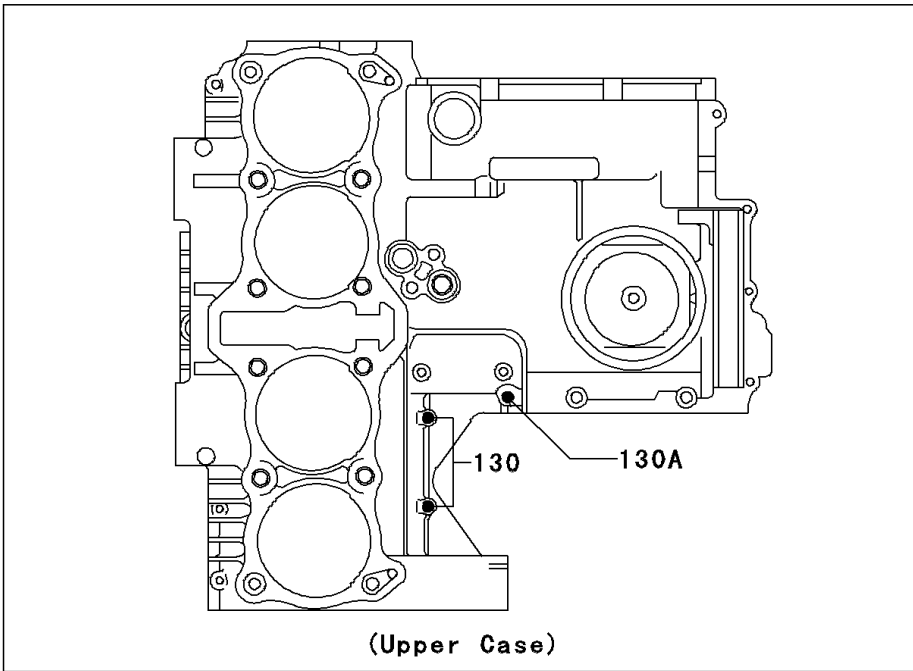

2005 Police 1000 PARTS LIST

Crankcase Bolt Pattern

ITEM NAME	PART NUMBER	QUANTITY
BOLT-FLANGED (Ref # 130)	130Y0640	9
BOLT-FLANGED (Ref # 130A)	130Y0650	1
BOLT-FLANGED (Ref # 130B)	130Y0695	1