

2019 MULE SX™ 4x4 XC CAMO FI PARTS DIAGRAM

Generator/Ignition Coil

E1811

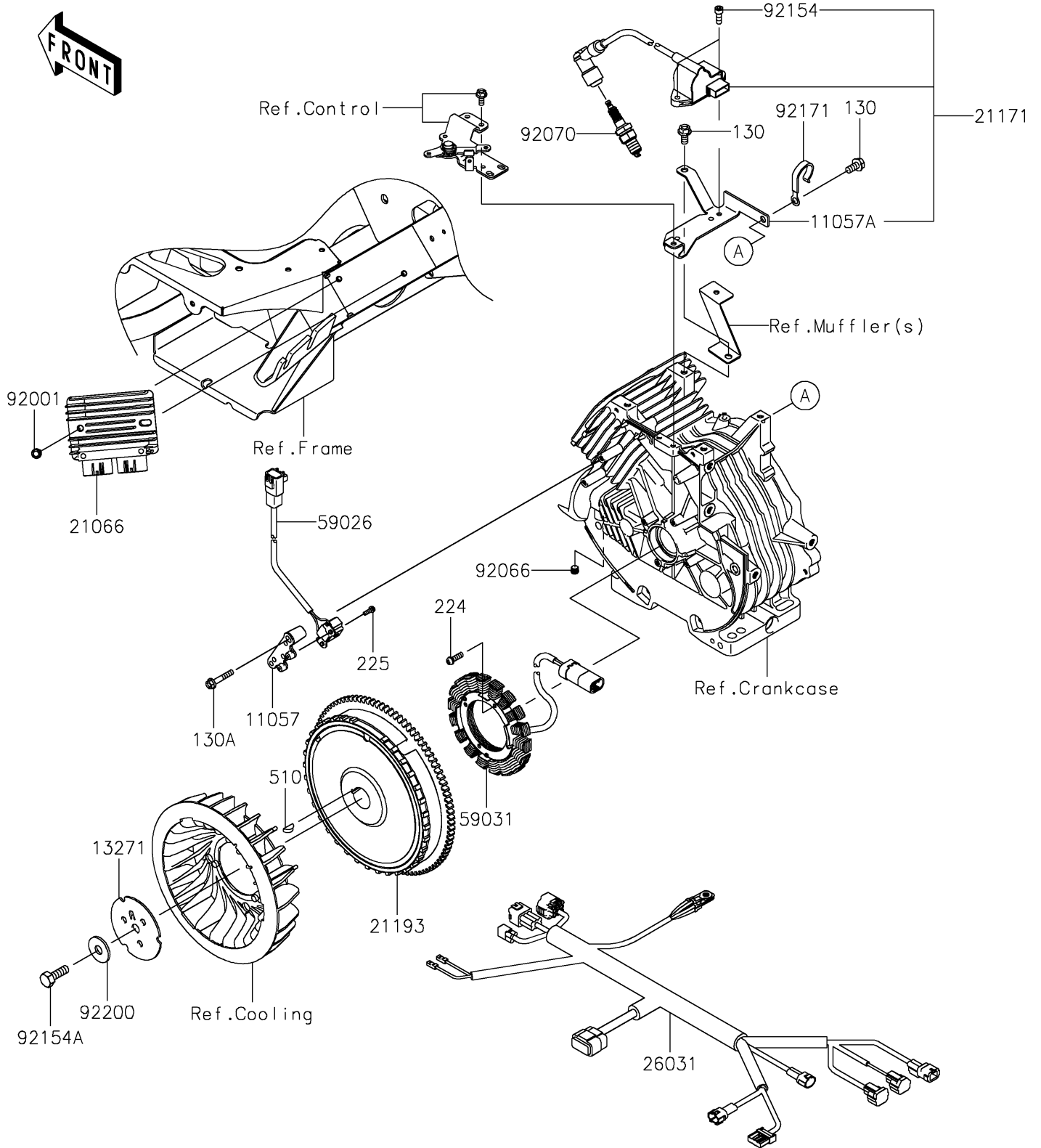

2019 MULE SX™ 4x4 XC CAMO FI PARTS LIST

Generator/Ignition Coil

ITEM NAME	PART NUMBER	QUANTITY
BRACKET (Ref # 11057)	11057-1547	1
BRACKET,COIL-ASSY-IGNITION (Ref # 11057A)	11057-1551	1
PLATE,FAN (Ref # 13271)	13271-7029	1
REGULATOR-VOLTAGE (Ref # 21066)	21066-0767	1
COIL-ASSY-IGNITION (Ref # 21171)	21171-0755	1
FLYWHEEL-ASSY (Ref # 21193)	21193-0711	1
HARNESS,SUB (Ref # 26031)	26031-2618	1
COIL-PULSING (Ref # 59026)	59026-0557	1
COIL-CHARGING (Ref # 59031)	59031-0014	1
BOLT,FLANGED,6X22 (Ref # 92001)	92001-1352	2
PLUG (Ref # 92066)	92066-0881	1
PLUG-SPARK,BPR5ES(NGK),SOLID (Ref # 92070)	92070-2088	1
BOLT (Ref # 92154)	92154-3735	2
BOLT,12X30 (Ref # 92154A)	92154-7003	1
CLAMP (Ref # 92171)	92171-7005	1
WASHER (Ref # 92200)	92200-7002	1
BOLT-FLANGED,8X16 (Ref # 130)	130AA0816	2
BOLT-FLANGED,6X35 (Ref # 130A)	130BA0635	2
SCREW-PAN-WP-CROS,5X25 (Ref # 224)	224AA0525	4
SCREW-PAN-WSP-CROS,4X14 (Ref # 225)	225AA0414	2
KEY-WOODRUFF (Ref # 510)	510A5100	1