

2020 MULE SX™ 4x4 XC LE FI PARTS DIAGRAM

Driven Converter/Drive Belt

E1392

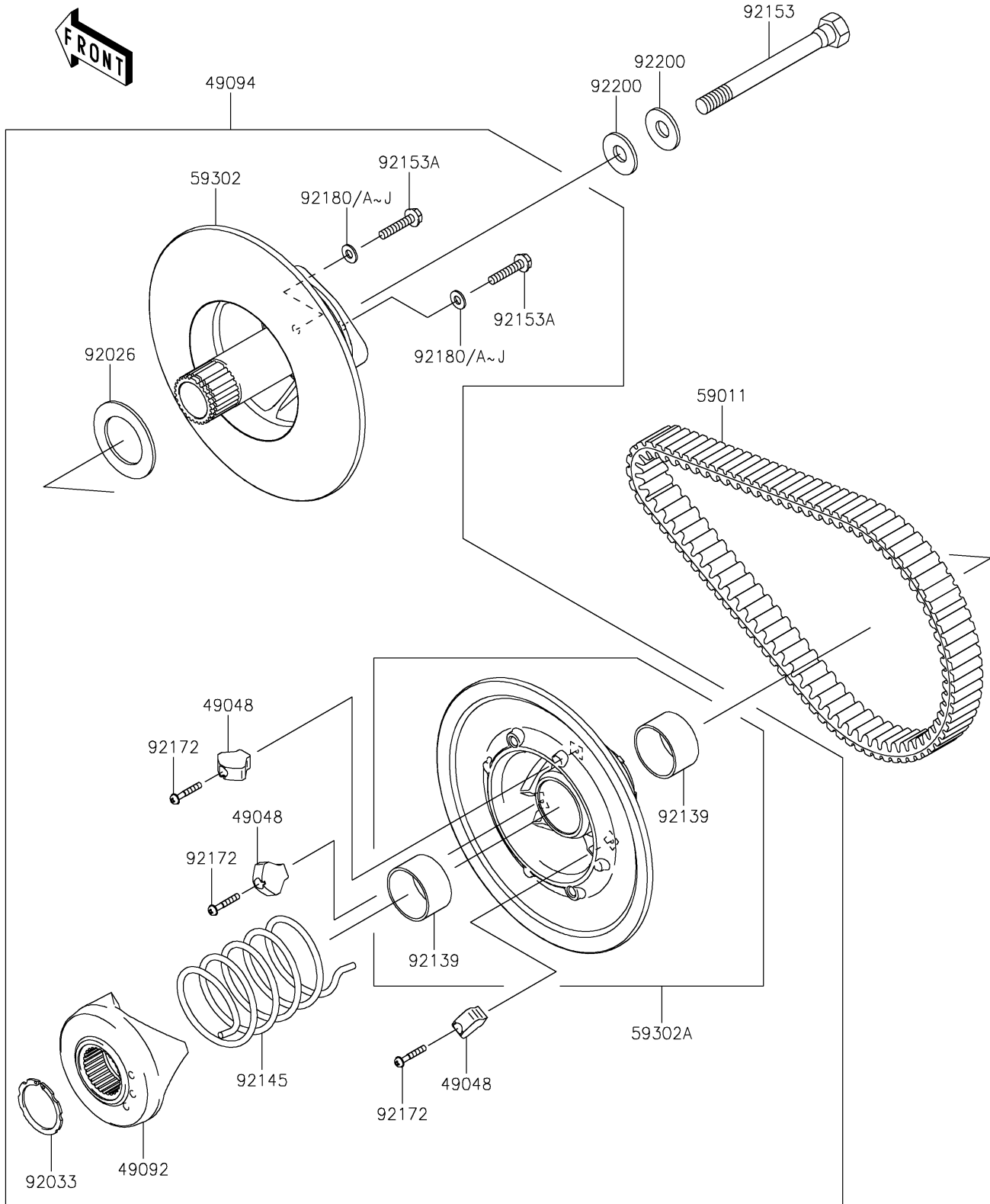

2020 MULE SX™ 4x4 XC LE FI PARTS LIST

Driven Converter/Drive Belt

ITEM NAME	PART NUMBER	QUANTITY
SHOE (Ref # 49048)	49048-0001	3
RAMP (Ref # 49092)	49092-0005	1
CONVERTER-ASSY-DRIVEN (Ref # 49094)	49094-0049	1
BELT (Ref # 59011)	59011-0011	1
SHEAVE-COMP, FIXED (Ref # 59302)	59302-0008	1
SHEAVE-COMP (Ref # 59302A)	59302-0098	1
SPACER, 38X60X2.5 (Ref # 92026)	92026-0046	1
RING-SNAP (Ref # 92033)	92033-0053	1
BUSHING (Ref # 92139)	92139-0054	2
SPRING (Ref # 92145)	92145-0743	1
BOLT, 12X121 (Ref # 92153)	92153-0593	1
BOLT, 6X28 (Ref # 92153A)	92153-0833	2
SCREW, 4X25 (Ref # 92172)	92172-0060	3
SHIM, T=0.8 (Ref # 92180)	92180-0150	AR
SHIM, T=1.0 (Ref # 92180A)	92180-0151	AR
SHIM, T=1.2 (Ref # 92180B)	92180-0152	AR
SHIM, T=1.4 (Ref # 92180C)	92180-0153	2
SHIM, T=1.6 (Ref # 92180D)	92180-0154	AR
SHIM, T=1.8 (Ref # 92180E)	92180-0155	AR
SHIM, T=2.0 (Ref # 92180F)	92180-0156	AR
SHIM, T=2.3 (Ref # 92180G)	92180-0157	AR
SHIM, T=2.5 (Ref # 92180H)	92180-0158	AR
SHIM, T=2.8 (Ref # 92180I)	92180-0159	AR
SHIM, T=3.2 (Ref # 92180J)	92180-0160	AR
WASHER (Ref # 92200)	92200-0249	2