

# 1988 LTD PARTS DIAGRAM

Transmission

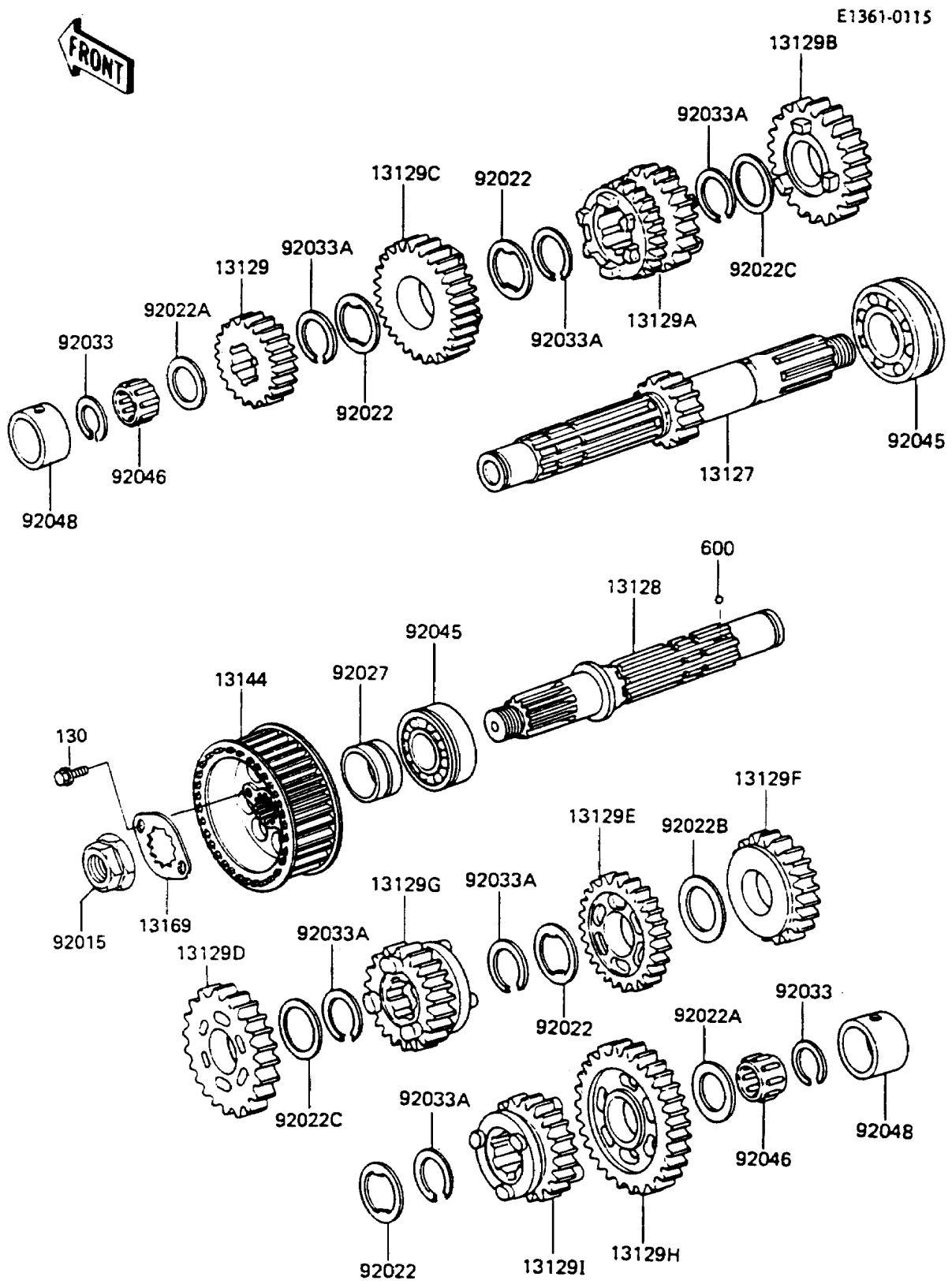

# 1988 LTD PARTS LIST

## Transmission

ITEM NAME	PART NUMBER	QUANTITY
SHAFT-TRANSMISSION INPUT (Ref # 13127)	13127-1056	1
SHAFT-TRANSMISSION OUTPUT (Ref # 13128)	13128-1053	1
GEAR,INPUT 2ND,19T (Ref # 13129)	13129-1086	1
GEAR,INPUT 3RD&4TH,22T&25T (Ref # 13129A)	13129-1087	1
GEAR,INPUT 5TH,27T (Ref # 13129B)	13129-1088	1
GEAR,INPUT TOP,28T (Ref # 13129C)	13129-1089	1
GEAR,OUTPUT 2ND,34T (Ref # 13129D)	13129-1091	1
GEAR,OUTPUT 3RD,31T (Ref # 13129E)	13129-1092	1
GEAR,OUTPUT 4TH,29T (Ref # 13129F)	13129-1093	1
GEAR,OUTPUT TOP,25T (Ref # 13129G)	13129-1095	1
GEAR,OUTPUT LOW,39T (Ref # 13129H)	13129-1254	1
GEAR,OUTPUT 5TH,27T (Ref # 13129I)	13129-1255	1
SPROCKET-OUTPUT,23T (Ref # 13144)	13144-1138	1
PLATE,LOCK (Ref # 13169)	13169-1742	1
NUT,20MM (Ref # 92015)	92015-1254	1
WASHER,TOOTHED,25.3X30X1 (Ref # 92022)	92022-1072	4
WASHER,20.5X30X1,STEEL (Ref # 92022A)	92022-112	2
WASHER,25.5X38X1 (Ref # 92022B)	92022-145	1
WASHER,25.3X30X0.5 (Ref # 92022C)	92022-159	2
COLLAR,ENGINE SPROCKET (Ref # 92027)	92027-1662	1
RING-SNAP,20MM (Ref # 92033)	92033-015	2
RING-SNAP,24MM (Ref # 92033A)	92033-026	6
BEARING-BALL,#6205NX3 (Ref # 92045)	92045-1013	2
BEARING-NEEDLE,20R2513P (Ref # 92046)	92046-044	2
RACE,NEEDLE BEARING (Ref # 92048)	92048-1003	2
BOLT-FLANGED,6X12 (Ref # 130)	130G0612	2
BALL-STEEL,5/32" (Ref # 600)	600A0500	3