

1988 LTD PARTS DIAGRAM

Oil Pump/Oil Filter

E1710-0011

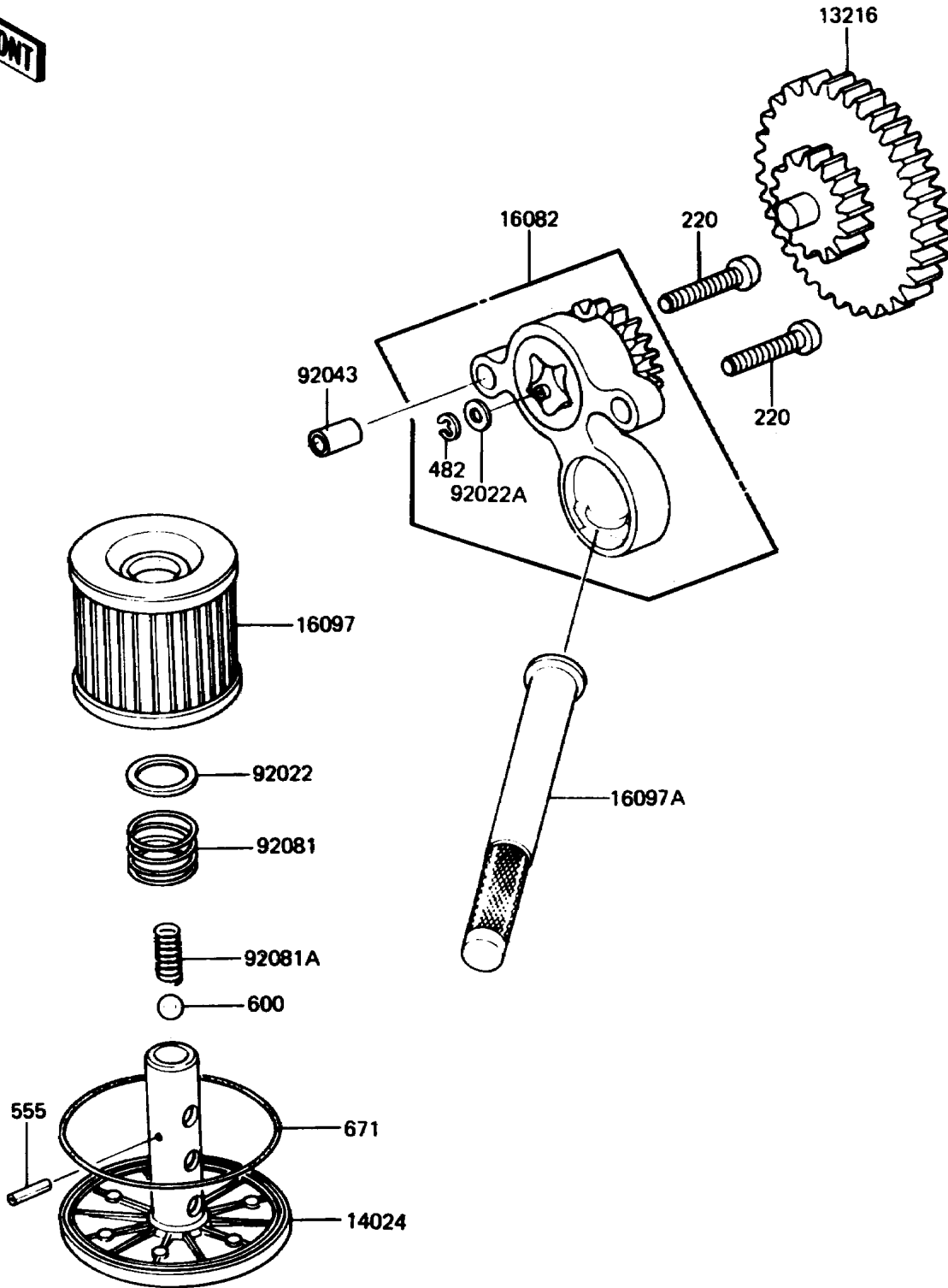

1988 LTD PARTS LIST

Oil Pump/Oil Filter

ITEM NAME	PART NUMBER	QUANTITY
GEAR-COMP,OIL PUMP (Ref # 13216)	13216-1031	1
COVER,OIL FILTER (Ref # 14024)	14025-1052	1
PUMP-ASSY-OIL (Ref # 16082)	16082-1007	1
FILTER-ASSY-OIL (Ref # 16097)	16097-1002	1
FILTER-ASSY-OIL (Ref # 16097A)	16097-1003	1
WASHER,19.5X26X0.8 (Ref # 92022)	41065-004	1
WASHER,5.5X9X0.6T (Ref # 92022A)	92022-1146	1
PIN,6.2X8X14 (Ref # 92043)	92043-1263	2
SPRING,OIL FILTER (Ref # 92081)	92081-1018	1
SPRING (Ref # 92081A)	92081-109	1
SCREW-PAN-CROS,6X30 (Ref # 220)	220B0630	2
CIRCLIP-TYPE-E,4MM (Ref # 482)	482J4000	1
PIN-SPRING,2X14 (Ref # 555)	555A0216	1
BALL-STEEL,3/8" (Ref # 600)	600A1200	1
O RING,65MM (Ref # 671)	671B2565	1