

2021 MULE SX™ 4x4 SE FI PARTS DIAGRAM

Front Brake Piping

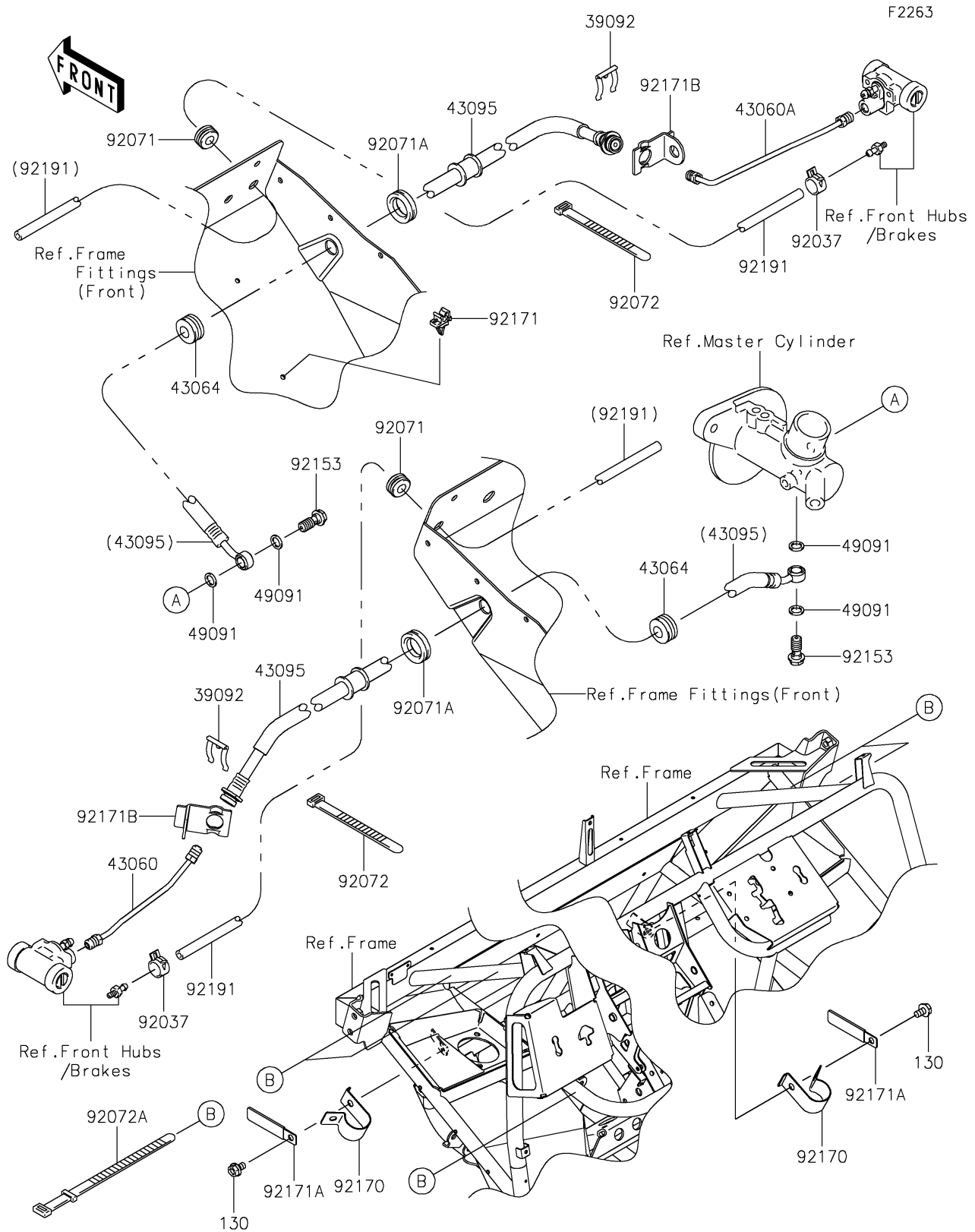

2021 MULE SX™ 4x4 SE FI PARTS LIST

Front Brake Piping

ITEM NAME	PART NUMBER	QUANTITY
-----------	-------------	----------