

2013 MULE™ 610 4x4 PARTS DIAGRAM

Valve(s)/Camshaft(s)

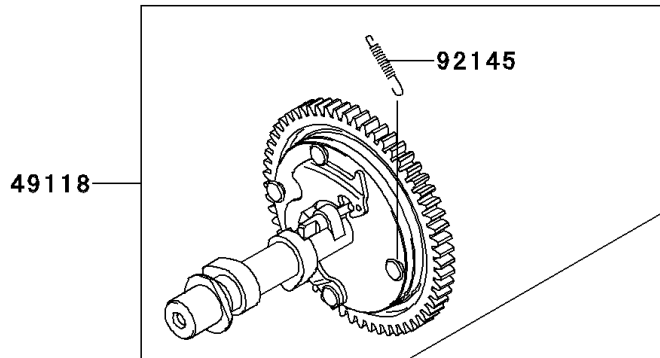

E1211

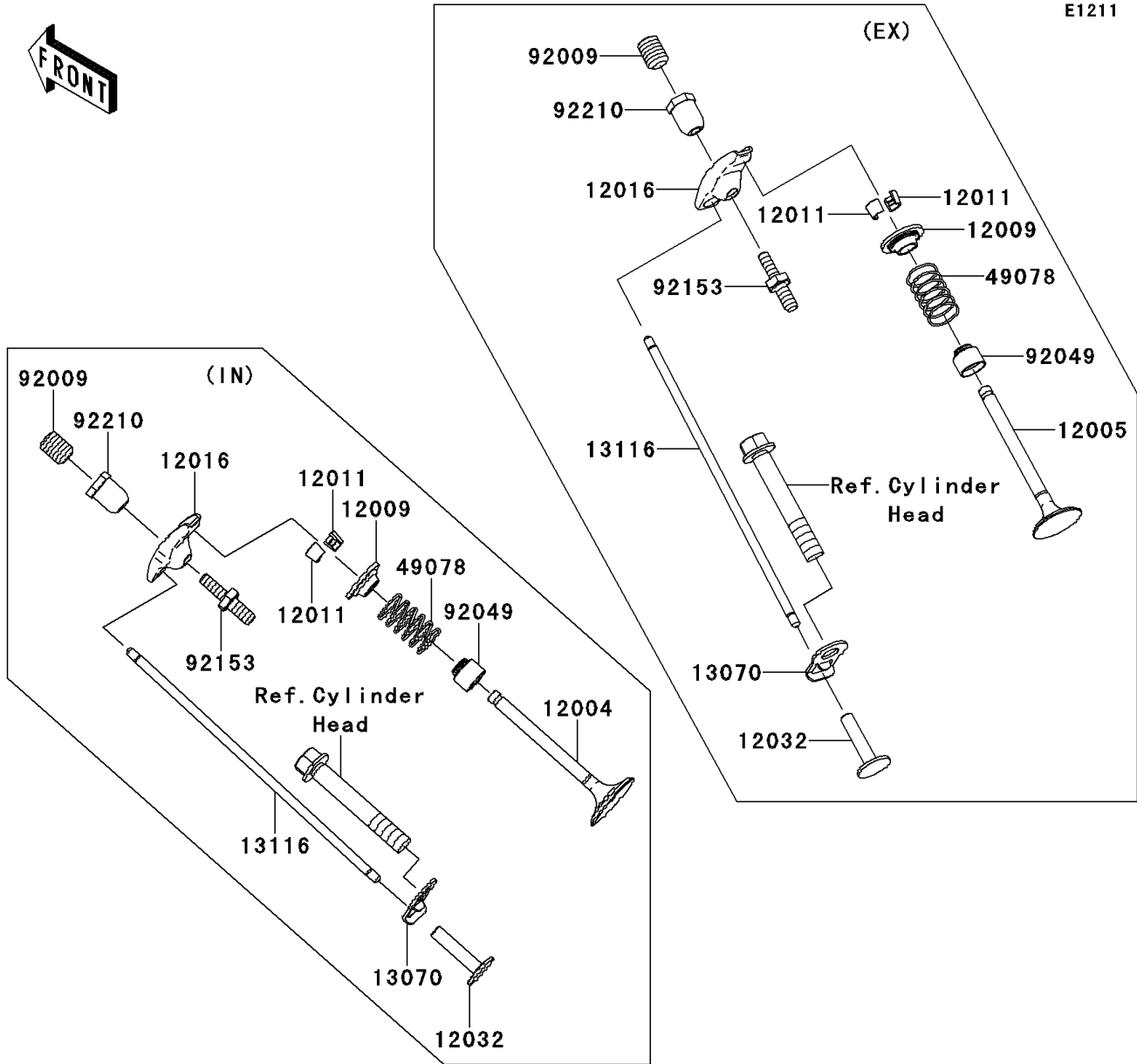

2013 MULE™ 610 4x4 PARTS LIST

Valve(s)/Camshaft(s)

ITEM NAME	PART NUMBER	QUANTITY
VALVE-INTAKE (Ref # 12004)	12004-7004	1
VALVE-EXHAUST (Ref # 12005)	12005-7013	1
RETAINER-VALVE SPRING (Ref # 12009)	12009-7004	2
COLLET (Ref # 12011)	12011-2052	4
ARM-ROCKER (Ref # 12016)	12016-7007	2
TAPPET (Ref # 12032)	12032-7001	2
GUIDE,ROD-PUSH (Ref # 13070)	13070-7012	2
ROD-PUSH (Ref # 13116)	13116-7004	2
SPRING-ENGINE VALVE (Ref # 49078)	49078-7003	2
CAMSHAFT-COMP (Ref # 49118)	49118-0762	1
SCREW (Ref # 92009)	92009-2341	2
SEAL-OIL,7X15X13 (Ref # 92049)	92049-7020	2
SPRING (Ref # 92145)	92145-7001	1
BOLT (Ref # 92153)	92153-7019	2
NUT,M6 (Ref # 92210)	92210-7033	2