

# 1991 Vulcan 88 PARTS DIAGRAM

## Battery Case

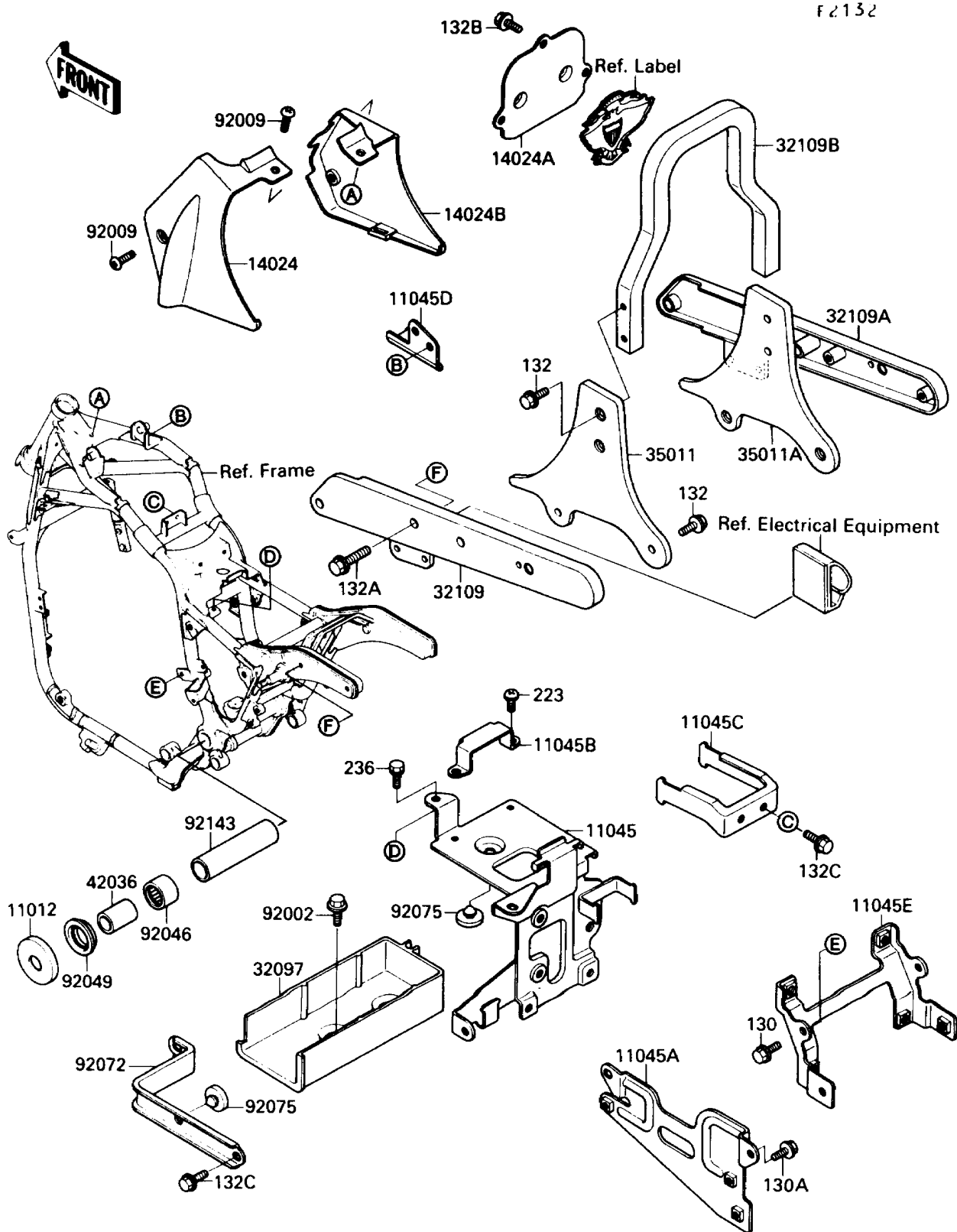

F2132

# 1991 Vulcan 88 PARTS LIST

## Battery Case

ITEM NAME	PART NUMBER	QUANTITY
CAP,SWING ARM (Ref # 11012)	11012-1575	2
BRACKET,ELECTRIC BASE (Ref # 11045)	11045-1451	1
BRACKET,IGNITER (Ref # 11045A)	11045-1452	1
BRACKET,JUNCTION BOX (Ref # 11045B)	11045-1453	1
BRACKET,FUEL PUMP (Ref # 11045C)	11045-1454	1
BRACKET,FUEL FILTER (Ref # 11045D)	11045-1455	1
BRACKET,IGNITION COIL (Ref # 11045E)	11045-1622	1
COVER,HEAD GUSSET,LH (Ref # 14024)	14024-1457	1
COVER,SEAT (Ref # 14024A)	14024-1459	1
COVER,HEAD GUSSET,RH (Ref # 14024B)	14024-1682	1
CASE-BATTERY (Ref # 32097)	32097-1130	1
GRIP-FRAME,LWR,LH (Ref # 32109)	32109-1157	1
GRIP-FRAME,LWR,RH (Ref # 32109A)	32109-1158	1
GRIP-FRAME,UPP (Ref # 32109B)	32109-1159	1
STAY,FRAME GRIP,LH (Ref # 35011)	35011-1336	1
STAY,FRAME GRIP,RH (Ref # 35011A)	35011-1337	1
SLEEVE,17.1X25X40 (Ref # 42036)	42036-1213	2
BOLT,6X12 (Ref # 92002)	92002-1721	2
SCREW,5X10 (Ref # 92009)	92009-1335	3
BEARING-NEEDLE,BHTM2530-1 (Ref # 92046)	92046-1035	2
SEAL-OIL (Ref # 92049)	92049-1166	2
BAND,BATTERY (Ref # 92072)	92072-1218	1
DAMPER,RUBBER (Ref # 92075)	92075-078	3
COLLAR,17.6X22.2X96.5 (Ref # 92143)	92143-1083	1
BOLT-FLANGED,6X14 (Ref # 130)	130C0614	2
BOLT-FLANGED (Ref # 130A)	130D0610	2
BOLT-FLANGED-SMALL,6X14 (Ref # 132)	132E0614	8
BOLT-FLANGED-SMALL (Ref # 132A)	132E0820	4
BOLT-FLANGED-SMALL (Ref # 132B)	132G0612	3

# 1991 Vulcan 88 PARTS LIST

## Battery Case

ITEM NAME	PART NUMBER	QUANTITY
BOLT-FLANGED-SMALL,6X10 (Ref # 132C)	132H0610	4
SCREW-PAN-WS-CROS (Ref # 223)	223B0510	2
SCREW-PAN-WSP-CROS (Ref # 236)	236D0612	2