

1991 Vulcan 88 PARTS DIAGRAM

Tire

F2210

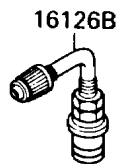
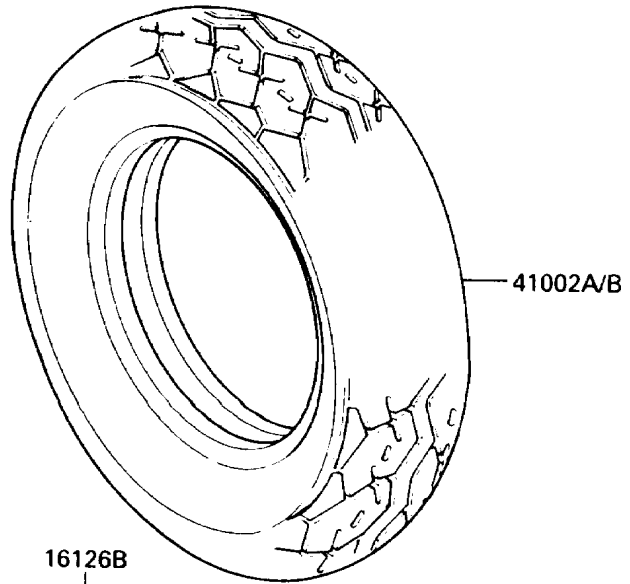
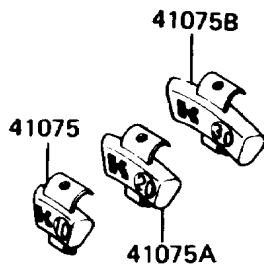
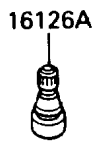
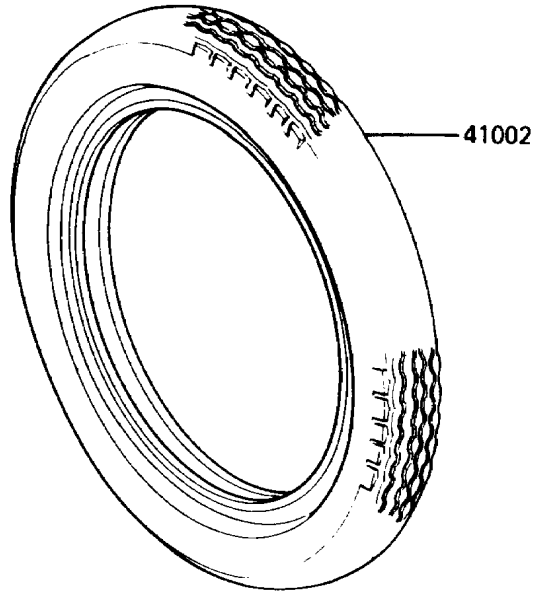
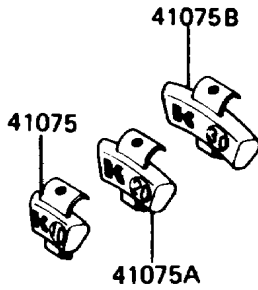

1991 Vulcan 88 PARTS LIST

Tire

ITEM NAME	PART NUMBER	QUANTITY
VALVE,TIRE (Ref # 16126A)	16126-1140	1
VALVE,TIRE (Ref # 16126B)	16126-1191	1
TIRE,FR,100/90-19 57H,F11J(D) (Ref # 41002)	41002-1623	1
TIRE,RR,150/90-15 M/C 74H,K425 (Ref # 41002B)	41002-1734	1
BALANCER-WHEEL,10G,SILVER (Ref # 41075)	41075-1014	AR
BALANCER-WHEEL,20G,SILVER (Ref # 41075A)	41075-1015	AR
BALANCER-WHEEL,30G,SILVER (Ref # 41075B)	41075-1016	AR