

2007 Vulcan 1600 Classic PARTS DIAGRAM

Frame Fittings

F2131

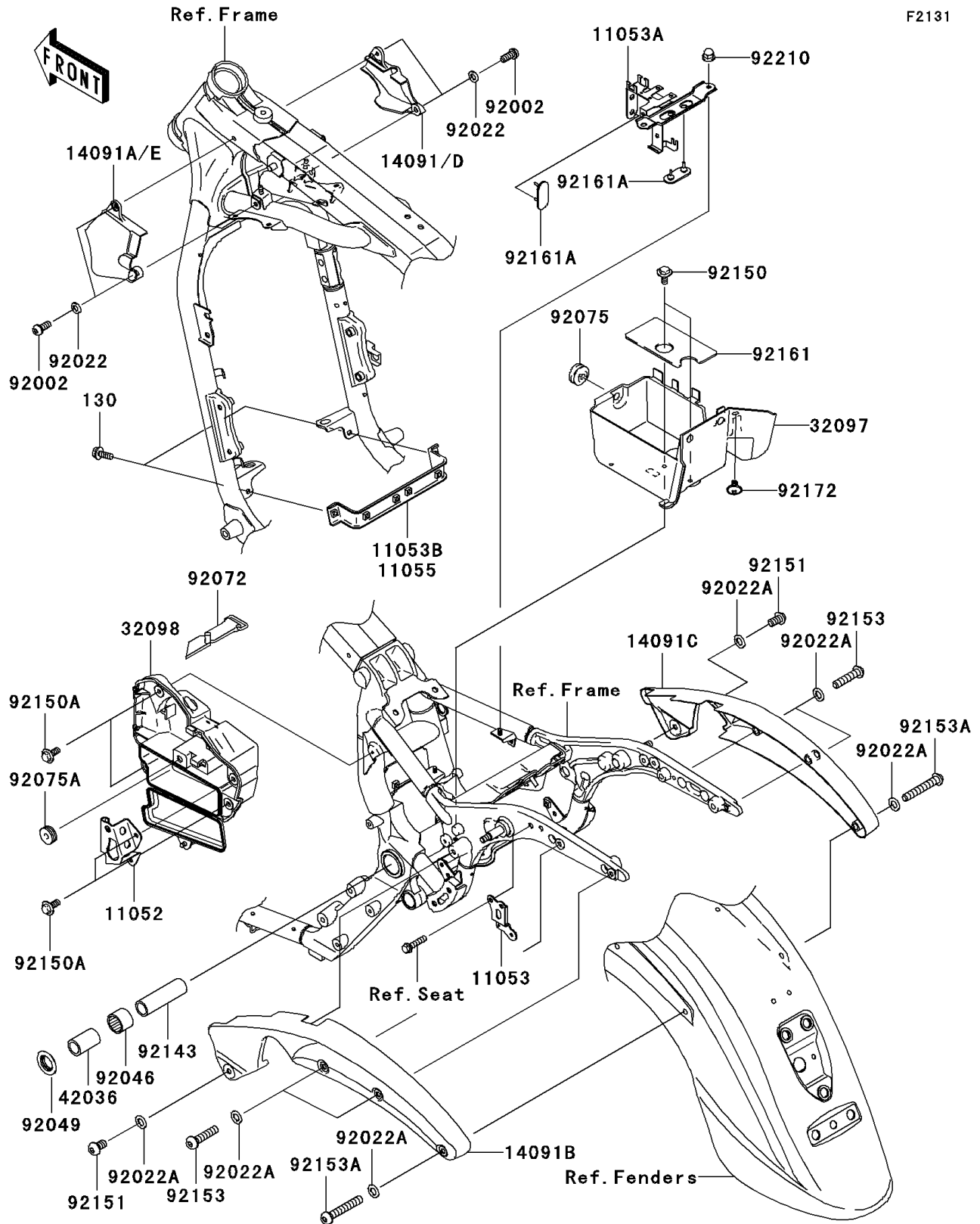

2007 Vulcan 1600 Classic PARTS LIST

Frame Fittings

ITEM NAME	PART NUMBER	QUANTITY
BOLT-FLANGED,6X16 (Ref # 130)	130J0616	2
BRACKET,SIDE COVER LOCK (Ref # 11052)	11052-1234	1
BRACKET,HELMET LOCK (Ref # 11053)	11053-0143	1
BRACKET,BATTERY BAND (Ref # 11053A)	11053-0289	1
BRACKET,REGULATOR (Ref # 11053B)	11053-0434	1
COVER,HEAD PIPE,RH (Ref # 14091)	14091-0054	1
COVER,HEAD PIPE,LH (Ref # 14091A)	14091-0092	1
COVER,FENDER,LH (Ref # 14091B)	14091-0380	1
COVER,FENDER,RH (Ref # 14091C)	14091-0381	1
CASE-BATTERY (Ref # 32097)	32097-1192	1
CASE-TOOL (Ref # 32098)	32098-1137	1
SLEEVE,L=45 (Ref # 42036)	42036-1330	2
BOLT,6X14 (Ref # 92002)	92002-1700	4
WASHER,6.2X11X1.5 (Ref # 92022)	92022-183	4
WASHER,PLAIN,8MM (Ref # 92022A)	92022-3043	8
BEARING-NEEDLE,BM2824 (Ref # 92046)	92046-1202	2
SEAL-OIL (Ref # 92049)	92049-1181	2
BAND,L=470 (Ref # 92072)	92072-1331	1
DAMPER (Ref # 92075)	92075-1067	1
DAMPER (Ref # 92075A)	92075-1629	1
COLLAR,20.2X27X90 (Ref # 92143)	92143-1878	1
BOLT,6X14 (Ref # 92150)	92150-1133	2
BOLT,6X16 (Ref # 92150A)	92150-1198	4
BOLT,8X14 (Ref # 92151)	92151-1438	2
BOLT,SOCKET,8X35 (Ref # 92153)	92153-0419	4
BOLT,SOCKET,8X50 (Ref # 92153A)	92153-0420	2
DAMPER,BATTERY (Ref # 92161)	92161-1097	1
DAMPER,BATTERY BAND (Ref # 92161A)	92161-1214	2
SCREW,6X10 (Ref # 92172)	92172-0005	2

2007 Vulcan 1600 Classic PARTS LIST

Frame Fittings

ITEM NAME	PART NUMBER	QUANTITY
NUT,CAP,6MM (Ref # 92210)	92210-0003	2