

1991 Vulcan 88 PARTS DIAGRAM

Electrical Equipment

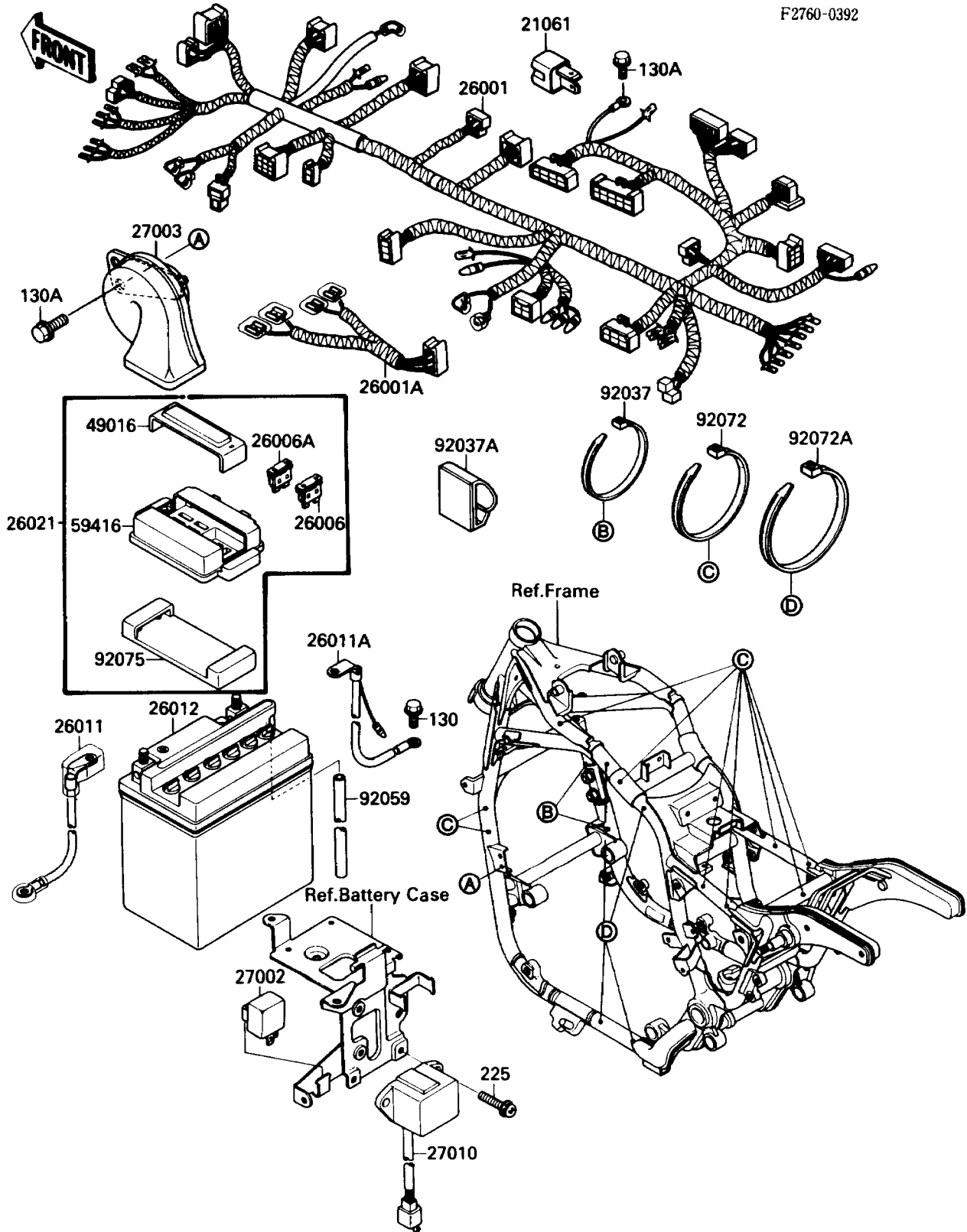

F2760-0392

1991 Vulcan 88 PARTS LIST

Electrical Equipment

ITEM NAME	PART NUMBER	QUANTITY
RECTIFIER (Ref # 21061)	21061-1003	1
HARNESS,MAIN (Ref # 26001)	26001-1831	1
HARNESS,IGNITION (Ref # 26001A)	26001-1862	1
FUSE,30A-G (Ref # 26006)	26006-1006	1
FUSE,10A-R (Ref # 26006A)	26006-1007	5
WIRE-LEAD,BATTERY(+) (Ref # 26011)	26011-1391	1
WIRE-LEAD,BATTERY(-) (Ref # 26011A)	26011-1392	1
BATTERY,12V 20AH,Y50-N18L-A (Ref # 26012)	26012-1187	1
JUNCTION BOX (Ref # 26021)	26021-1068	1
RELAY-ASSY,TURN SIGNAL (Ref # 27002)	27002-1053	1
HORN,LOW TONE (Ref # 27003)	27003-1264	1
SWITCH,RESERVE LIGHTING (Ref # 27010)	27010-1069	1
COVER-SEAL,FUSE (Ref # 49016)	49016-1125	1
CASE-ELECTRIC,JUNCTION BOX (Ref # 59416)	59416-1065	1
CLAMP,BAND,L=137 (Ref # 92037)	92037-1817	2
CLAMP,WIRING HARNESS (Ref # 92037A)	92037-1954	2
TUBE,5X8X570 (Ref # 92059)	92059-1840	1
BAND,L=185 (Ref # 92072)	92072-1195	9
BAND,L=365 (Ref # 92072A)	92072-1197	4
DAMPER,JUNCTION BOX (Ref # 92075)	92075-1688	1
BOLT-FLANGED,6X10 (Ref # 130)	130B0610	1
BOLT-FLANGED,6X10,BLACK (Ref # 130A)	130C0610	3
SCREW-PAN-WSP-CROS (Ref # 225)	225B0620	2