

1990 Vulcan 88 PARTS DIAGRAM

Ignition Switch

F2770-0332

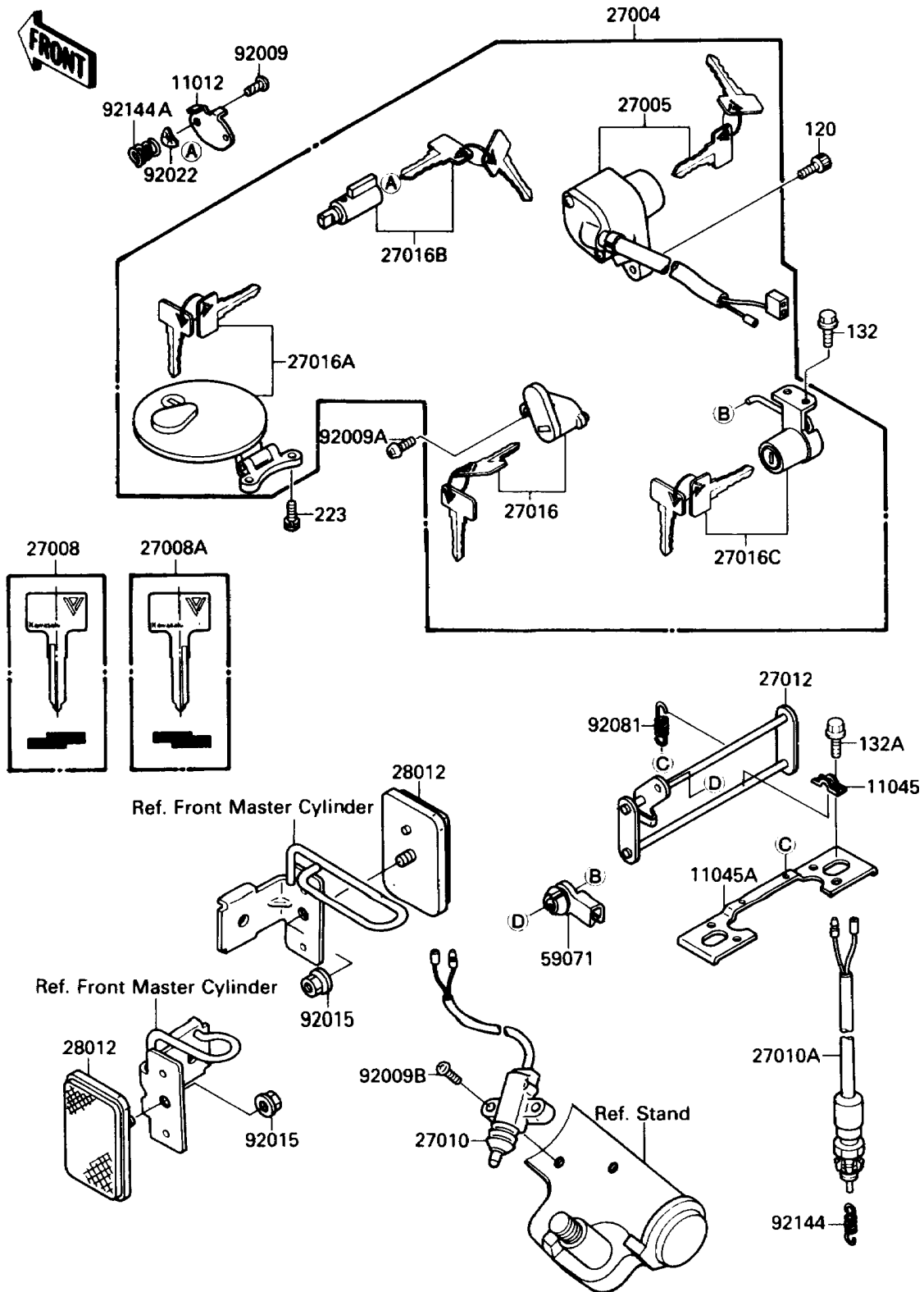

1990 Vulcan 88 PARTS LIST

Ignition Switch

ITEM NAME	PART NUMBER	QUANTITY
CAP,STEERING LOCK (Ref # 11012)	11012-1586	1
BRACKET,SEAT HOOK (Ref # 11045)	11045-1700	2
BRACKET,SEAT HOOK (Ref # 11045A)	11045-1701	1
SWITCH-ASSY (Ref # 27004)	27004-5310	1
SWITCH-ASSY-IGNITION (Ref # 27005)	27005-1128	1
KEY-LOCK,BLANK,#A (Ref # 27008)	27008-1138	1
KEY-LOCK,BLANK,#B (Ref # 27008A)	27008-1139	1
SWITCH,SIDE STAND (Ref # 27010)	27010-1223	1
SWITCH,REAR BRAKE (Ref # 27010A)	27010-1238	1
HOOK,SEAT (Ref # 27012)	27012-1371	1
LOCK-ASSY,HELMET (Ref # 27016)	27016-5129	1
LOCK-ASSY,FUEL TANK COVER (Ref # 27016A)	27016-5130	1
LOCK-ASSY,STEERING (Ref # 27016B)	27016-5131	1
LOCK-ASSY,SEAT (Ref # 27016C)	27016-5132	1
REFLECTOR-REFLEX,FR (Ref # 28012)	28012-1009	2
JOINT (Ref # 59071)	59071-1103	1
SCREW,3.51MM (Ref # 92009)	92008-007	1
SCREW,5X12 (Ref # 92009A)	92009-1296	1
SCREW,5X20 (Ref # 92009B)	92009-1459	2
NUT,FLANGED,5MM (Ref # 92015)	92015-1656	2
WASHER,WAVE (Ref # 92022)	92097-003	1
SPRING,HOOK RETURN (Ref # 92081)	92081-1466	2
SPRING,REAR BRAKE SWITCH (Ref # 92144)	92144-1141	1
SPRING,STEERING LOCK (Ref # 92144A)	92144-1222	1
BOLT-SOCKET (Ref # 120)	120P0512	1
BOLT-FLANGED-SMALL (Ref # 132)	132G0608	2
BOLT-FLANGED-SMALL (Ref # 132A)	132J0612	4
SCREW-PAN-WS-CROS (Ref # 223)	223B0410	2