

# 2022 KX™ 450X PARTS DIAGRAM

Cylinder Head

E1111

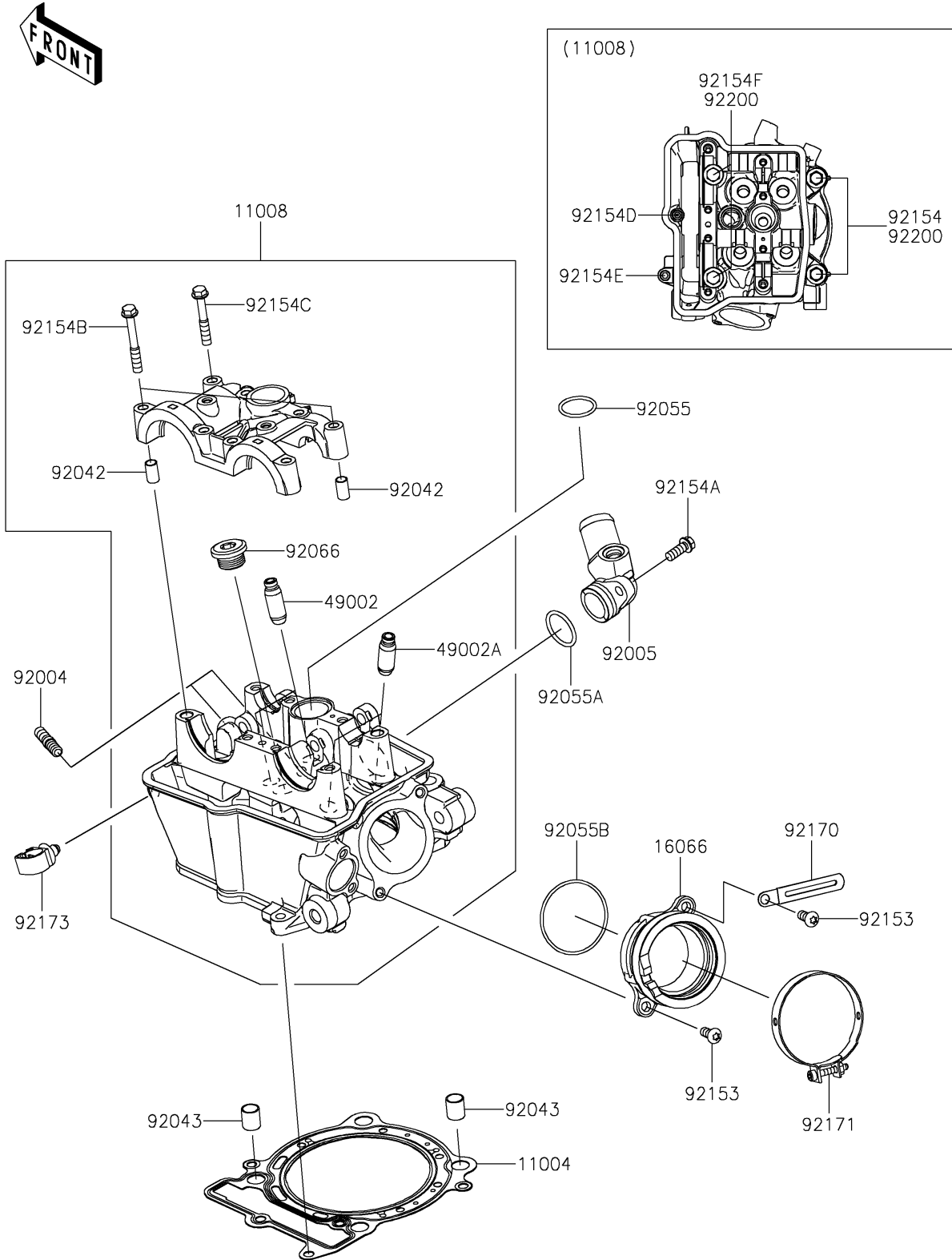

## 2022 KX™ 450X PARTS LIST

### Cylinder Head

ITEM NAME	PART NUMBER	QUANTITY
GASKET-HEAD (Ref # 11004)	11004-0796	1
HEAD-COMP-CYLINDER (Ref # 11008)	11008-0975	1
HOLDER-THROTTLE BODY (Ref # 16066)	16066-0010	1
GUIDE-VALVE (Ref # 49002)	49002-0020	2
GUIDE-VALVE (Ref # 49002A)	49002-0042	2
STUD,8X22 (Ref # 92004)	92004-0025	2
FITTING (Ref # 92005)	92005-0896	1
PIN,DOWEL,6.3X8X14 (Ref # 92042)	92042-007	2
PIN,10.1X12X14 (Ref # 92043)	92043-4009	2
RING-O,23.5X2.0 (Ref # 92055)	92055-0046	1
RING-O,22.1X2.4 (Ref # 92055A)	92055-1081	1
RING-O,47X1.9 (Ref # 92055B)	92055-1600	1
PLUG,18X10 (Ref # 92066)	92066-0832	1
BOLT,TORX,6X14 (Ref # 92153)	92153-0406	2
BOLT,FLANGED,10X127 (Ref # 92154)	92154-2455	2
BOLT,FLANGED,6X16 (Ref # 92154A)	92154-2965	1
BOLT,FLANGED,6X42 (Ref # 92154B)	92154-2979	2
BOLT,FLANGED,6X35 (Ref # 92154C)	92154-2983	6
BOLT,SOCKET,6X70 (Ref # 92154D)	92154-3867	1
BOLT-SOCKET,6X25 (Ref # 92154E)	92154-3960	1
BOLT,FLANGED,10X148 (Ref # 92154F)	92154-4126	2
CLAMP (Ref # 92170)	92170-1514	1
CLAMP (Ref # 92171)	92171-1552	1
CLAMP,12MM DIA. (Ref # 92173)	92173-0736	1
WASHER,10.2X18.4X1.8 (Ref # 92200)	92200-1691	4