

2022 KX™ 450X PARTS DIAGRAM

Clutch

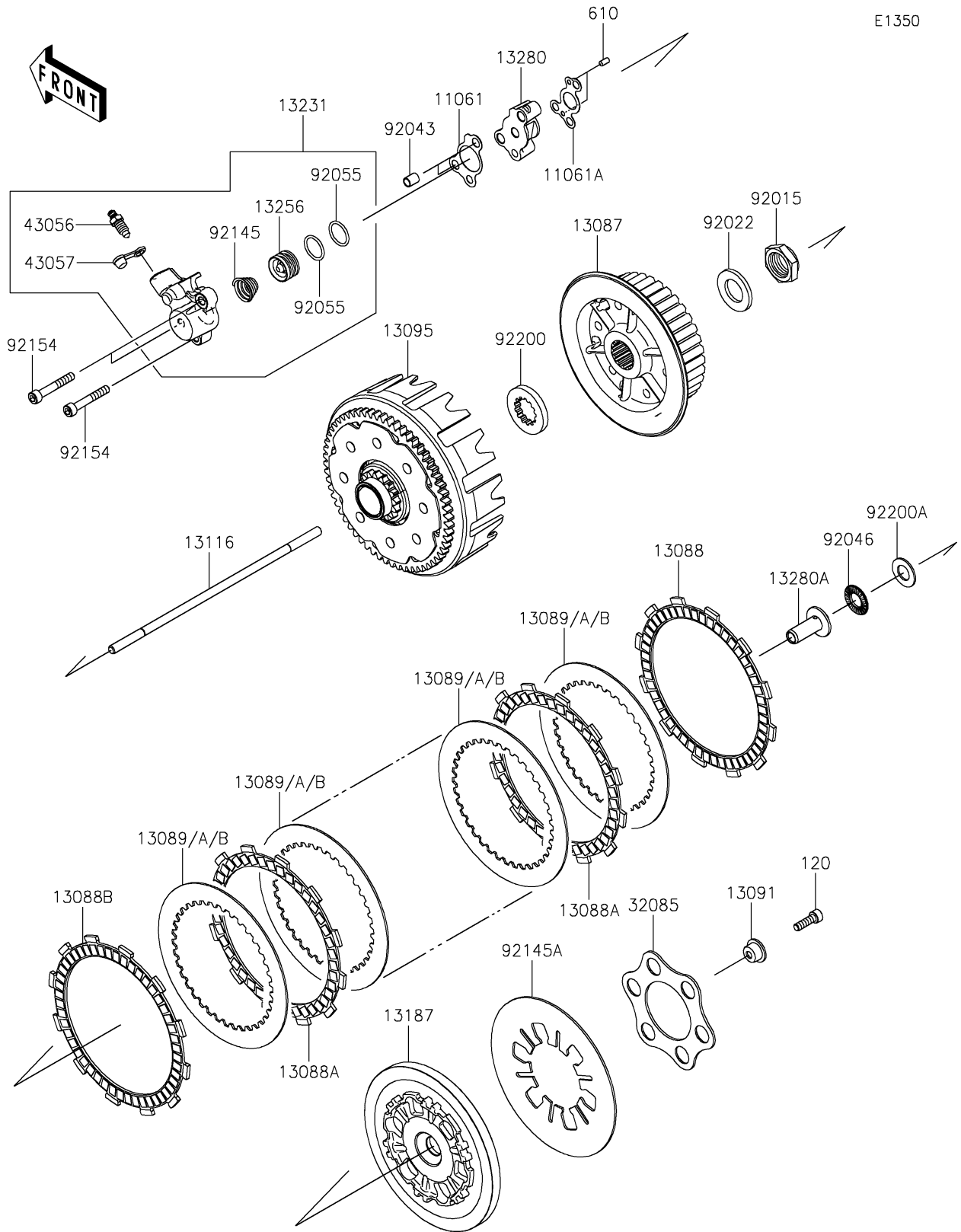

2022 KX™ 450X PARTS LIST

Clutch

ITEM NAME	PART NUMBER	QUANTITY
GASKET,RELEASE SIDE (Ref # 11061)	11061-1295	1
GASKET,CRANKCASE SIDE (Ref # 11061A)	11061-1296	1
HUB-CLUTCH (Ref # 13087)	13087-0592	1
PLATE-FRICTION (Ref # 13088)	13088-0573	1
PLATE-FRICTION (Ref # 13088A)	13088-0604	6
PLATE-FRICTION (Ref # 13088B)	13088-0619	1
PLATE-CLUTCH,T=1.6 (Ref # 13089)	13089-0559	7
PLATE-CLUTCH,T=2.0 (Ref # 13089A)	13089-0561	AR
PLATE-CLUTCH,T=1.4 (Ref # 13089B)	13089-0562	AR
HOLDER,CLUTCH SPRING (Ref # 13091)	13091-1840	6
HOUSING-COMP-CLUTCH (Ref # 13095)	13095-0603	1
ROD-PUSH (Ref # 13116)	13116-0740	1
PLATE-CLUTCH OPERATING (Ref # 13187)	13187-0036	1
RELEASE-ASSY-CLUTCH (Ref # 13231)	13231-0010	1
PISTON (Ref # 13256)	13256-0009	1
HOLDER,RELEASE BASE (Ref # 13280)	13280-0916	1
HOLDER,PUSHER (Ref # 13280A)	13280-0919	1
STOPPER (Ref # 32085)	32085-0875	1
BREATHER (Ref # 43056)	43056-1055	1
CAP-BREATHER (Ref # 43057)	43057-1001	1
NUT,20MM (Ref # 92015)	92015-1725	1
WASHER,20.3X36X3.7 (Ref # 92022)	92022-1868	1
PIN,DOWEL,8X10 (Ref # 92043)	92043-1302	2
BEARING-NEEDLE,FNTA-1326 (Ref # 92046)	92046-1190	1
RING-O (Ref # 92055)	92055-0931	2
SPRING (Ref # 92145)	92145-1863	1
SPRING (Ref # 92145A)	92145-1942	1
BOLT,SOCKET,6X40 (Ref # 92154)	92154-3779	3
WASHER,25X41X5.5 (Ref # 92200)	92200-0245	1

2022 KX™ 450X PARTS LIST

Clutch

ITEM NAME	PART NUMBER	QUANTITY
WASHER,13.4X25.0X1.5 (Ref # 92200A)	92200-1548	1
BOLT-SOCKET,6X20 (Ref # 120)	120Q0620	6
ROLLER,4X8 (Ref # 610)	610A0408	2