

1999 Vulcan 1500 PARTS DIAGRAM

Swingarm

F2141

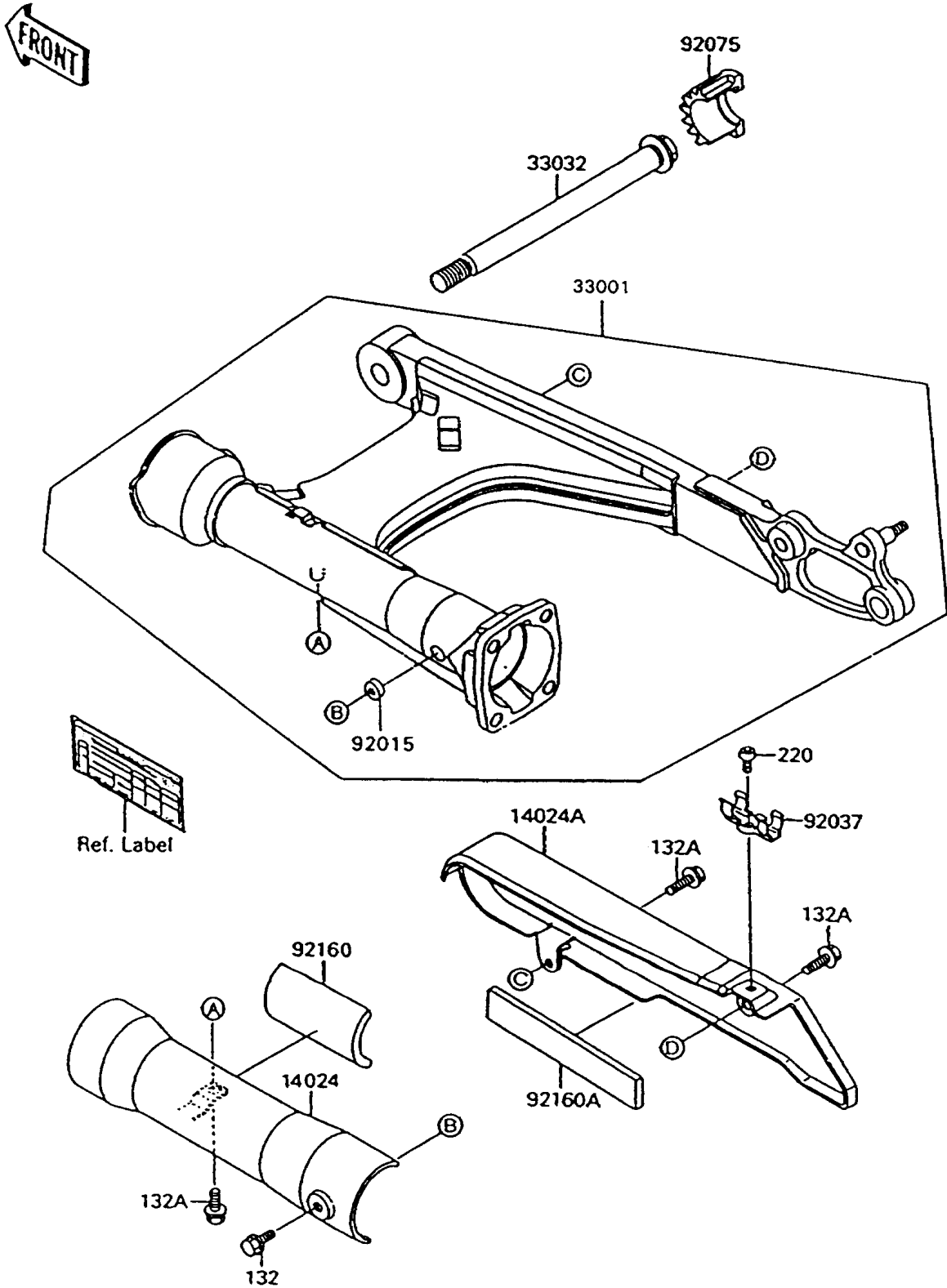

1999 Vulcan 1500 PARTS LIST

Swingarm

ITEM NAME	PART NUMBER	QUANTITY
BOLT-FLANGED-SMALL (Ref # 132)	132E0610	1
BOLT-FLANGED-SMALL (Ref # 132A)	132E0612	3
SCREW-PAN-CROS,5X8 (Ref # 220)	220E0508	1
COVER,SWING ARM,LH (Ref # 14024)	14024-1410	1
COVER,SWING ARM,RH (Ref # 14024A)	14024-1411	1
ARM-COMP-SWING,SILVER NO.25 (Ref # 33001)	33001-1453-CE	1
SHAFT-SWING ARM (Ref # 33032)	33032-1131	1
NUT,POP,6MM,L=14 (Ref # 92015)	92015-1629	2
CLAMP (Ref # 92037)	92037-1879	1
DAMPER,SWING ARM COVER (Ref # 92075)	92075-1917	1
DAMPER (Ref # 92160)	92160-1004	1
DAMPER,SWING ARM COVER,RH (Ref # 92160A)	92160-1005	1