

# 2007 Vulcan 1600 Classic PARTS DIAGRAM

Front Wheel

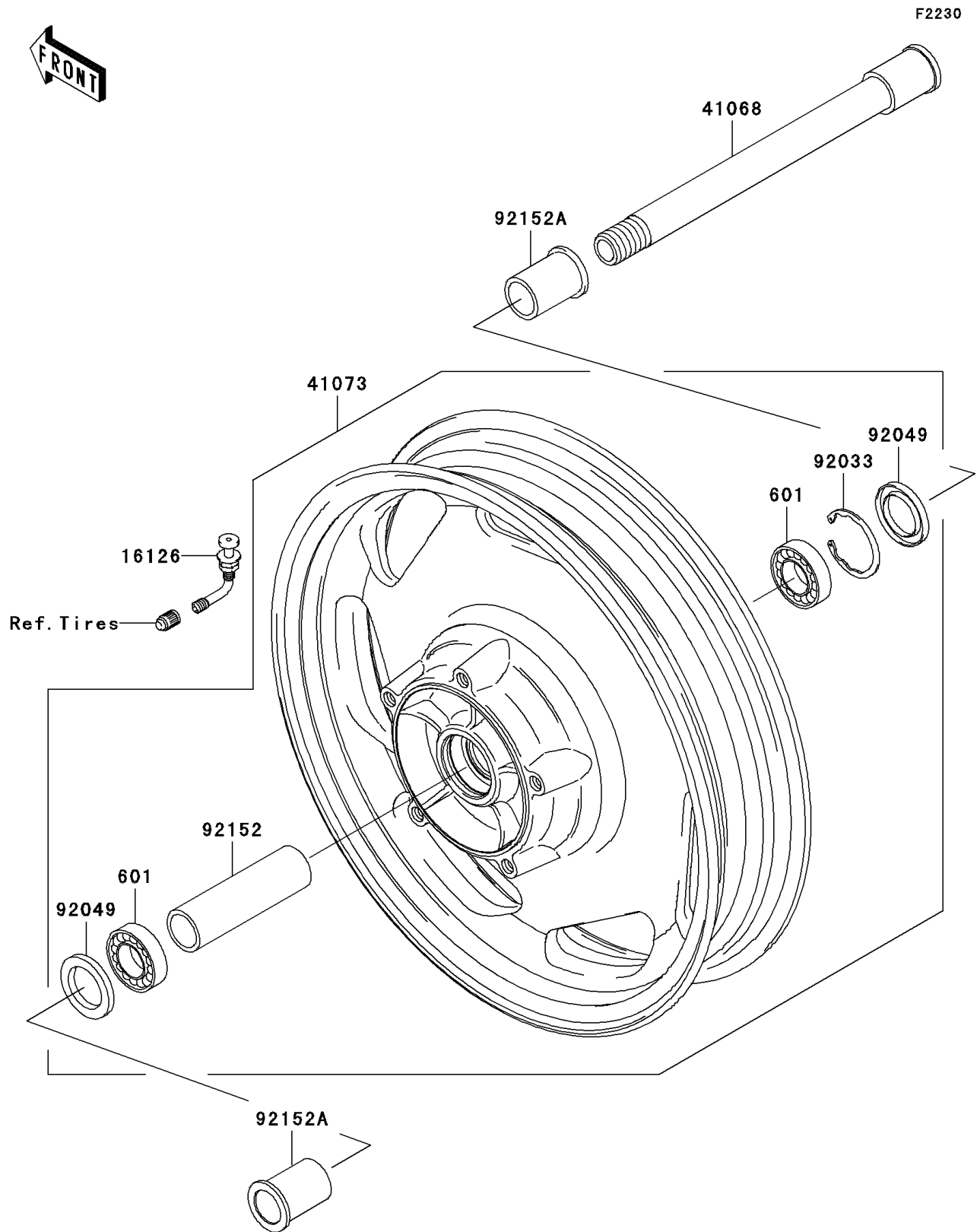

## 2007 Vulcan 1600 Classic PARTS LIST

### Front Wheel

ITEM NAME	PART NUMBER	QUANTITY
BEARING-BALL,#6005UU (Ref # 601)	601B6005UU	2
VALVE (Ref # 16126)	16126-1365	1
AXLE,FR (Ref # 41068)	41068-1465	1
WHEEL-ASSY,FR (Ref # 41073)	41073-0031	1
RING-SNAP,47MM (Ref # 92033)	92033-1042	1
SEAL-OIL,BJN-C2 32X47X5 (Ref # 92049)	92049-0050	2
COLLAR,FR HUB,L=109 (Ref # 92152)	92152-1308	1
COLLAR,FR HUB,L=46.5 (Ref # 92152A)	92152-1492	2