

1994 Vulcan 88 PARTS DIAGRAM

Crankshaft

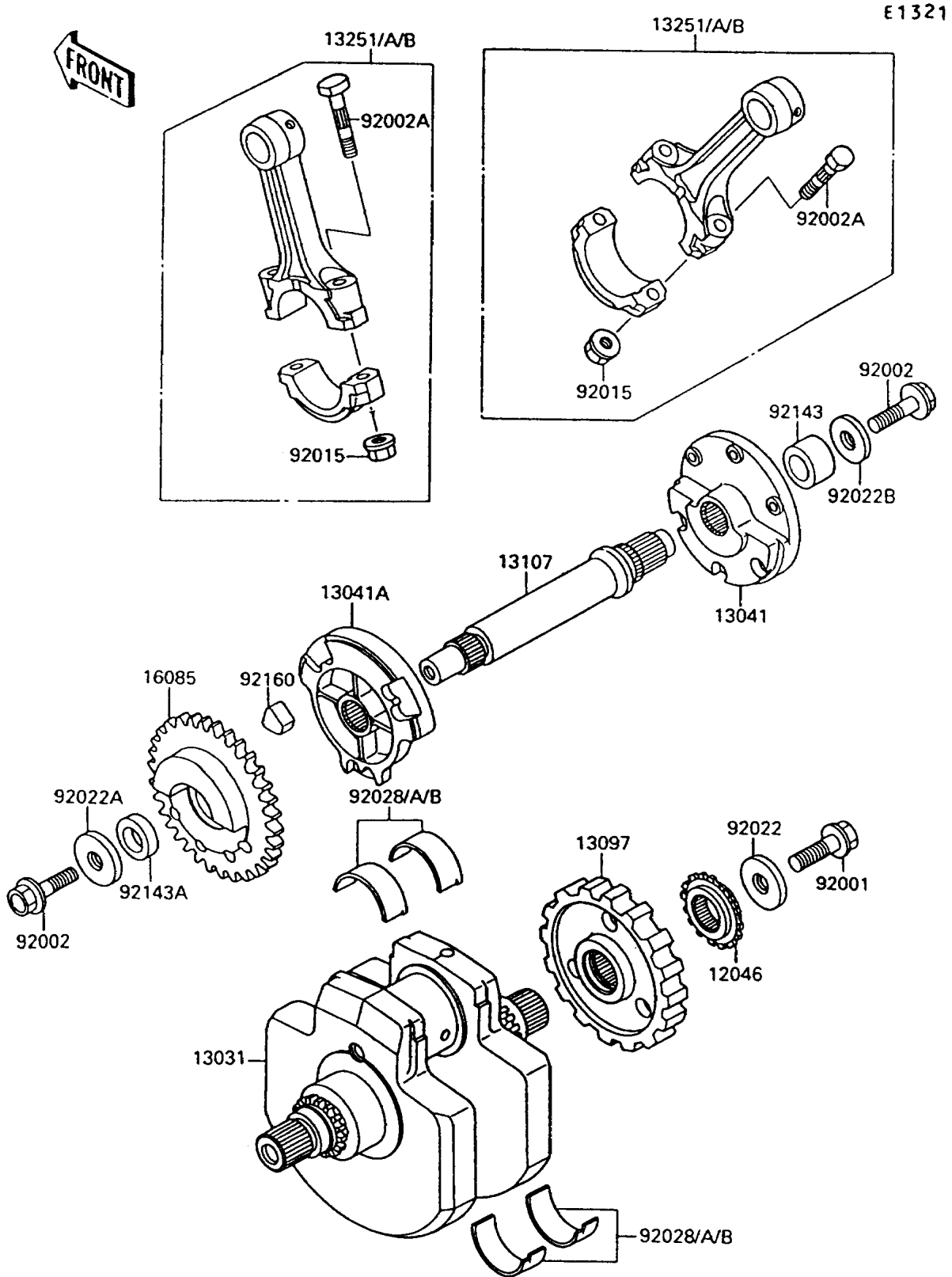

1994 Vulcan 88 PARTS LIST

Crankshaft

| ITEM NAME | PART NUMBER | QUANTITY |
|---|---------------|----------|
| SPROCKET,WATER PUMP (Ref # 12046) | 12046-1103 | 1 |
| CRANKSHAFT-COMP (Ref # 13031) | 13031-1242 | 1 |
| BALANCER (Ref # 13041) | 13041-1089 | 1 |
| BALANCER,LH (Ref # 13041A) | 13041-1093 | 1 |
| GEAR-PRIMARY SPUR,56T (Ref # 13097) | 13097-1202 | 1 |
| SHAFT,BALANCER (Ref # 13107) | 13107-1195 | 1 |
| ROD-ASSY-CONNECTING,F (Ref # 13251) | 13251-1080-FF | 2 |
| ROD-ASSY-CONNECTING,G (Ref # 13251A) | 13251-1080-GG | 2 |
| ROD-ASSY-CONNECTING,H (Ref # 13251B) | 13251-1080-HH | 2 |
| GEAR,BALANCER (Ref # 16085) | 16085-1215 | 1 |
| BOLT,FLANGED,12X40 (Ref # 92001) | 92001-1146 | 1 |
| BOLT,FLANGED,10X40 (Ref # 92002) | 92002-1296 | 2 |
| BOLT,CONNECTING ROD (Ref # 92002A) | 92002-1896 | 4 |
| NUT,CONNECTING ROD (Ref # 92015) | 92015-1643 | 4 |
| WASHER,GENERATOR (Ref # 92022) | 92022-1904 | 1 |
| WASHER,LH,10X40X9 (Ref # 92022A) | 92022-1905 | 1 |
| WASHER,RH,10X33X9 (Ref # 92022B) | 92022-1906 | 1 |
| BUSHING,CONNECTING ROD,BLUE (Ref # 92028) | 92028-1474 | AR |
| BUSHING,CONNECTING ROD,BLACK (Ref # 92028A) | 92028-1475 | AR |
| BUSHING,CONNECTING ROD,BROWN (Ref # 92028B) | 92028-1476 | AR |
| COLLAR,20X30X24 (Ref # 92143) | 92143-1093 | 1 |
| COLLAR,20X31X10 (Ref # 92143A) | 92143-1126 | 1 |
| DAMPER (Ref # 92160) | 92160-1024 | 3 |