

# 1993 Vulcan 88 PARTS DIAGRAM

Gear Change Drum/Shift Fork(s)

E1362

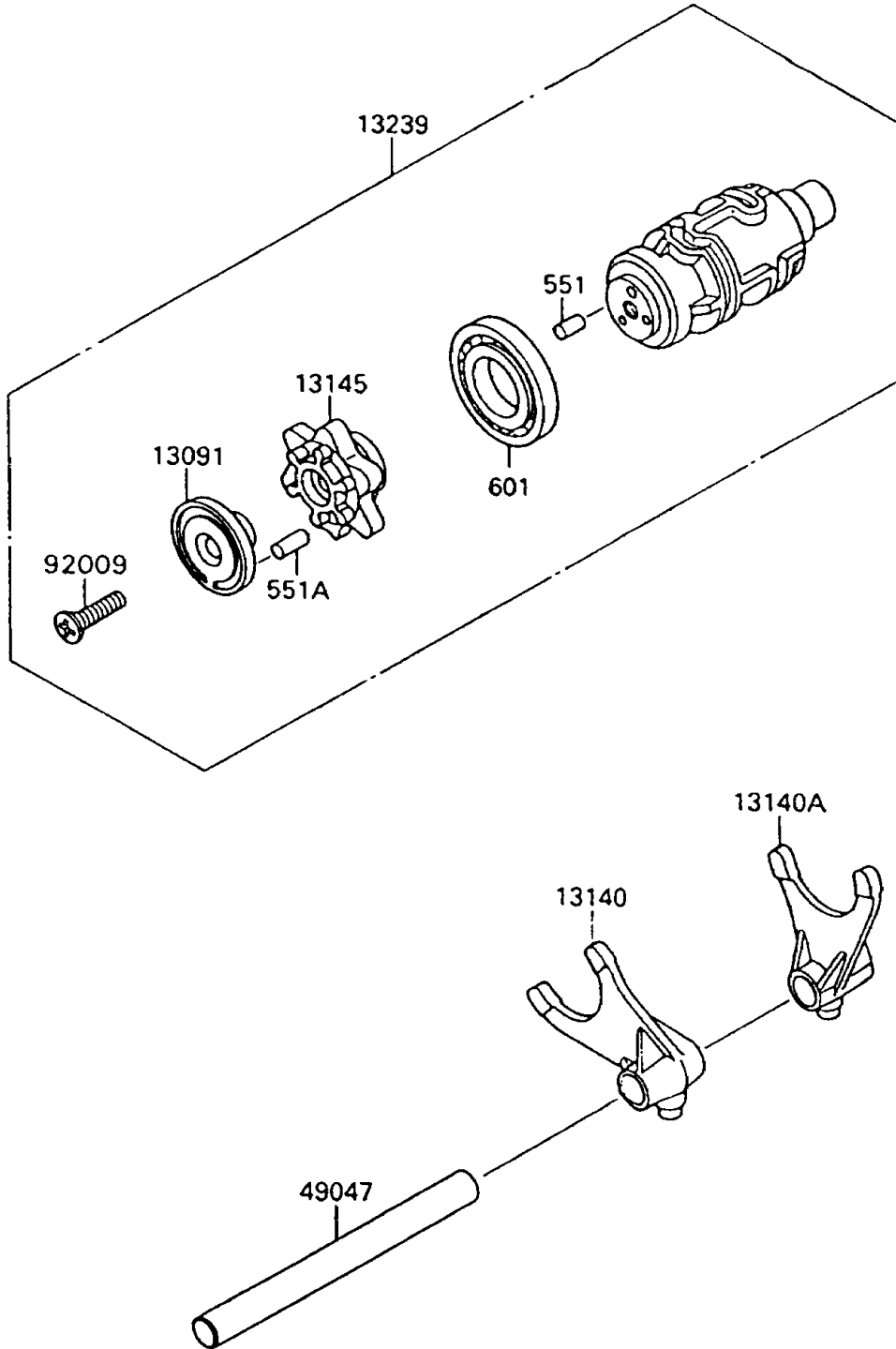

# 1993 Vulcan 88 PARTS LIST

## Gear Change Drum/Shift Fork(s)

ITEM NAME	PART NUMBER	QUANTITY
PIN-DOWEL,4X8 (Ref # 551)	551A0408	1
PIN-DOWEL (Ref # 551A)	551A0412	1
BEARING-BALL (Ref # 601)	601A6005	1
HOLDER,CHANGE DRUM PIN (Ref # 13091)	13091-1104	1
FORK-SHIFT,INPUT,2ND (Ref # 13140)	13140-1155	1
FORK-SHIFT,OUTPUT,3RD (Ref # 13140A)	13140-1156	1
CAM-CHANGE DRUM (Ref # 13145)	13145-1062	1
DRUM-ASSY-CHANGE (Ref # 13239)	13239-1141	1
ROD-SHIFT (Ref # 49047)	49047-1062	1
SCREW,6X45 (Ref # 92009)	92009-1599	1