

1994 Vulcan 88 PARTS DIAGRAM

Ignition System

E1830

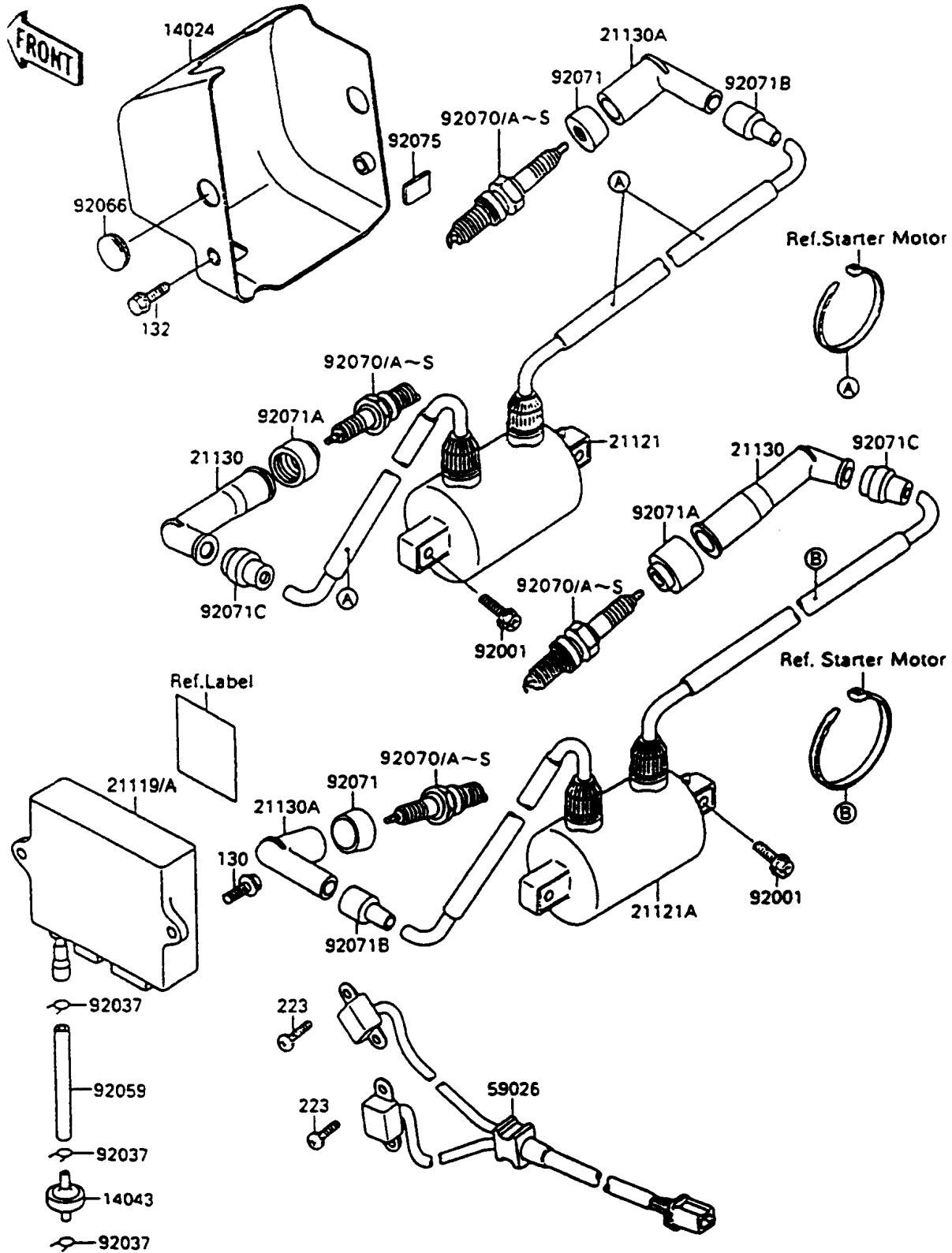

1994 Vulcan 88 PARTS LIST

Ignition System

ITEM NAME	PART NUMBER	QUANTITY
COVER,IGNITION COIL (Ref # 14024)	14024-1527	1
FILTER (Ref # 14043)	14043-1060	1
IGNITER (Ref # 21119)	21119-1217	1
COIL-IGNITION,FR (Ref # 21121)	21121-1154	1
COIL-IGNITION,RR (Ref # 21121A)	21121-1155	1
CAP-SPARK PLUG (Ref # 21130)	21130-1002	2
CAP-SPARK PLUG (Ref # 21130A)	21130-1003	2
COIL-PULSING (Ref # 59026)	59026-1085	1
BOLT,6X20 (Ref # 92001)	92001-1091	4
CLAMP,TUBE (Ref # 92037)	92037-1482	3
TUBE,3X7X140 (Ref # 92059)	92059-1687	1
PLUG (Ref # 92066)	92066-1286	2
PLUG-SPARK,DPR8EA-9(NGK) (Ref # 92070A)	92070-1065	4
PLUG-SPARK,DP8EA-9(NGK) (Ref # 92070C)	92070-1066	4
PLUG-SPARK,X24EPR-U9(ND) (Ref # 92070E)		4
PLUG-SPARK,X24EP-U9(ND) (Ref # 92070G)		4
PLUG-SPARK,X22EP-U9(ND) (Ref # 92070H)		4
BOLT-FLANGED,6X14 (Ref # 130)	130G0614	2
BOLT-FLANGED-SMALL (Ref # 132)	132J0616	2
SCREW-PAN-WS-CROS (Ref # 223)	223B0516	4
PLUG-SPARK,X22EPR-U9(ND) (Ref # 92070I)		4
PLUG-SPARK,DP7EA9(NGK) (Ref # 92070J)	92070-1124	4
PLUG-SPARK,DPR7EA9(NGK) (Ref # 92070K)	92070-1125	4
PLUG-SPARK,DP6EA-9(NGK) (Ref # 92070M)	92070-1136	4
PLUG-SPARK,X20EP-U9(DN) (Ref # 92070O)		4
PLUG-SPARK,DPR6EA9(NGK) (Ref # 92070Q)	92070-1138	4
PLUG-SPARK,X20EPR-U9(DN) (Ref # 92070S)		4
GROMMET,SPARK PLUG CAP (Ref # 92071)	92071-1015	2
GROMMET,PLUG CAP (Ref # 92071A)	92071-1124	2